

Not Riddled

madia / sideboard
HORM / Steven Holl, 2007
» [catalog #02](#)



Not Riddled

Steven Holl / 2007

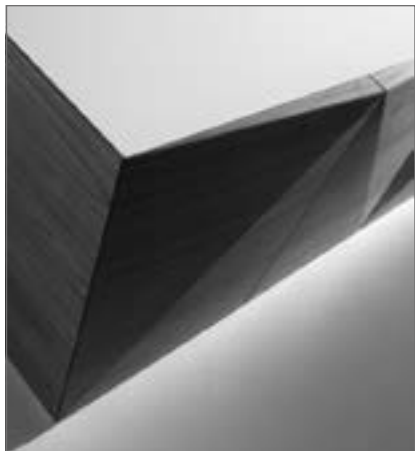

Cad models
Catalogues
Warranty terms
Assembly instructions
Product sheet
Technical sheet



NEED HELP? Call us: +39 0434 1979 100

Struttura in pannelli di particelle di legno o in MDF laccati. Fianchi ed ante realizzati con un materiale creato e brevettato da Horm composto da un sandwich di tranciato di noce canaleto e tessuto dello spessore di 2,2 mm che, grazie a delle incisioni superficiali eseguite con taglio laser, viene piegato come un origami. Ripiani in vetro temperato trasparente, bordo filo lucido, spessore mm 5.

Structure made from lacquered particleboard or MDF. Sides and doors made from a material designed and patented by Horm, composed of a sandwich of walnut veneer and fabric 2.2 mm thick, which, thanks to a number of superficial incisions made with a laser cutter, can be folded up like origami. Transparent tempered glass shelves, with polished edge, 5 mm thick.

Structure en panneaux de particules de bois ou de MDF laqués. Côtés et portes en un matériau créé et breveté par Horm, composé d'un sandwich de noyer tranché et d'un tissu de 2,2 mm d'épaisseur qui, grâce aux gravures de surface réalisées par découpe laser, est plié comme un origami. Étagères en verre trempé transparent, bord poli, épaisseur 5 mm.

Struktur aus lackierter Spanplatte oder MDF. Seitenwände und Schranktüren aus einem von Horm entwickelten und patentierten Material realisiert, bestehend aus einem Nusbaumfurnier-Gewebe Sandwich mit einer Stärke von 2,2 mm, das dank der mit Laserschnitt ausgeführten Oberflächeneinschnitten wie ein Gegenstand aus der Origami-Kunst gefaltet wird. Einlegeböden aus transparent Hartglas, polierte Kante, Stärke 5 mm.

Estructura en paneles de partículas de madera o de MDF lacados. Costados y puertas realizados con un material realizado y patentado por Horm, compuesto por un sandwich de chapa de nogal y tejido de espesor de 2.2mm, que gracias a las incisiones superficiales efectuadas con láser, se dobla como un origami. Baldas en vidrio templado transparente, borde filo brillante, espesor 5 mm.

+++
Le ante sono state sottoposte a 50.000 cicli di apertura superando brillantemente il test: "Durata delle porte UNI 8607:2005."

+++
The doors have been subjected to 50,000 opening and closing cycles and passed the test for: "Durability of doors UNI 8607:2005" with flying colours.

+++
Les portes ont été soumises à 50.000 cycles d'ouverture et ont brillamment passé le test de qualité: "Durée des portes UNI 8607:2005".

+++
Die Türen wurden 50.000 Öffnungszyklen unterzogen und haben den Test blendend bestanden: "Lebensdauer der Türen UNI 8607:2005".

+++
Las puertas han sido sometidas a 50000 ciclos de apertura superando brillantemente el test. "Duración de las puertas UNI 8607:2005"

BASAMENTI METALLICI
L'altezza dei contenitori (cm 66-98) include i piedini in ABS cm 2H. I piedini possono essere sostituiti da un basamento metallico cm 16H o 32H. Vedi prezzi e modelli a pagina 540.

METAL BASIS
The height of the sideboards (cm 66-98) includes the ABS feet cm 2H. The feet can be replaced by a metal base cm 16H or 32H. See prices and models on page 540.

BASES MÉTALLIQUES
La hauteur des buffets (cm 66-98) comprend les pieds en ABS cm 2H. Les pieds peuvent être remplacés par une base métallique cm 16H ou 32H. Voir prix et modèles à la page 540.

METAL BASIS
Die Höhe der Behälter (cm 66-98) beinhaltet die ABS-FüÙe cm 2H. FüÙe können durch einen Metallfuß cm 16H oder 32H ersetzt werden. Siehe Preise und Modelle auf der Seite 540

BASES METÁLICAS
La altura de los aparadores (cm 66-98) incluye los pies en ABS cm 2H. Los pies pueden ser substituidos por una base metálica cm 16H o 32H. Ver precios y modelos en página 540.

MISURE INTERNE

INTERNAL DIMENSIONS

DIMENSIONS INTERNES

INNENMASSE

DIMENSIONES INTERNAS

H 66

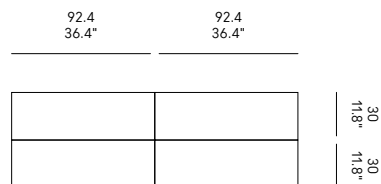

H 98

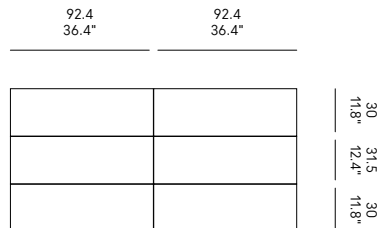

4 Ante / 4 Doors

4 Ante / 4 Doors

TOP E SCHIENA TOP AND BACK TOP ET DOSSIER TOP UND RÜCKEN TOP Y PARTE TRASERA LUCIDO GLOSSY BRILLANTE GLÄNZEND BRILLANTE	Nero Black Noir Schwarz Negro RAL 9011	Bianco White Blanc Weiß Blanco RAL 9016	Polvere Dusty grey Gris poussière Staubgrau Gris polvo RAL 7037	Beige Beige grey Gris beige Beigegrau Gris beige RAL 7006	Rosso vino Wine red Rouge vin Weinrot Rojo vino RAL 3005	Bruno Brown grey Gris brun Braungrau Gris parduzco RAL 7013	Grafite Graphite Graphite Graphit Grafito RAL 7024
<p>cm 192 x 50 x 66H 75.6" x 19.7" x 26.0"H</p>	ZD830ZLX	ZD830BLX	ZD830GPLX	ZD830GBLX	ZD830RVLX	ZD830GRLX	ZD830HLX
<p>cm 192 x 50 x 98H 75.6" x 19.7" x 38.6"H</p>	ZD840ZLX	ZD840BLX	ZD840GPLX	ZD840GBLX	ZD840RVLX	ZD840GRLX	ZD840HLX
TOP E SCHIENA TOP AND BACK TOP ET DOSSIER TOP UND RÜCKEN TOP Y PARTE TRASERA OPACO MATT MAT MATT OPACO	Nero Black Noir Schwarz Negro RAL 9011	Bianco White Blanc Weiß Blanco RAL 9016	Polvere Dusty grey Gris poussière Staubgrau Gris polvo RAL 7037	Beige Beige grey Gris beige Beigegrau Gris beige RAL 7006	Rosso vino Wine red Rouge vin Weinrot Rojo vino RAL 3005	Bruno Brown grey Gris brun Braungrau Gris parduzco RAL 7013	Grafite Graphite Graphite Graphit Grafito RAL 7024
<p>cm 192 x 50 x 66H 75.6" x 19.7" x 26.0"H</p>	ZD830ZX	ZD830BX	ZD830GPX	ZD830GBX	ZD830RVX	ZD830GRX	ZD830HX
<p>cm 192 x 50 x 98H 75.6" x 19.7" x 38.6"H</p>	ZD840ZX	ZD840BX	ZD840GPX	ZD840GBX	ZD840RVX	ZD840GRX	ZD840HX

Basamenti Metallici / Metal Bases / Bases Métalliques Metall Basis / Bases Metálicas

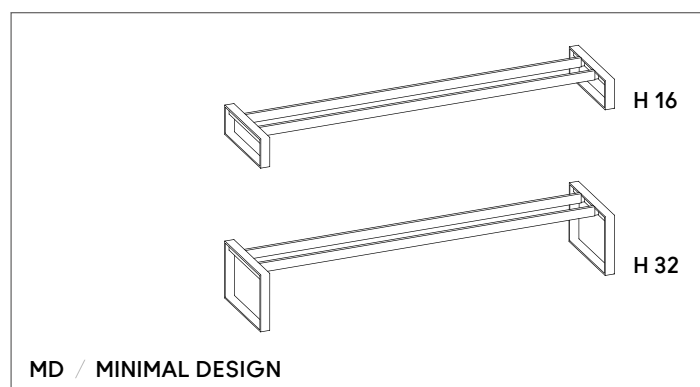
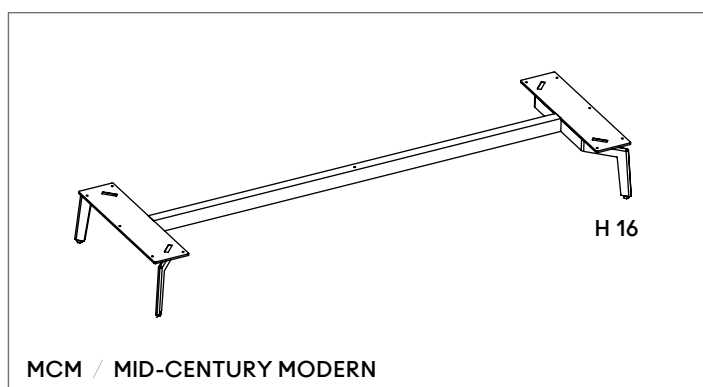

L'altezza dei contenitori indicata nel listino include i piedini H2 cm. Su richiesta del cliente, e con un supplemento prezzo, i contenitori possono montare un basamento metallico in alternativa ai piedini H2 cm. I basamenti sono disponibili in due modelli (MCM e MD) e due altezze (H16 e H32 cm).

The height of the sideboards indicated in the price list includes the feet H2 cm. At the customer's request, and for an additional price, the sideboards can be fitted with a metal base as an alternative to the H2 cm feet. The bases are available in two models (MCM and MD) and two heights (H16 and H32 cm).

La hauteur des contenieurs dans la liste de prix comprend les pieds H2 cm. Sur demande du client et moyennant un supplément de prix, les conteneurs peuvent être équipés d'une base métallique en alternative. Les bases sont disponibles en deux modèles (MCM et MD) et hauteurs (H16 et H32cm).

Die in der Preisliste angegebene Höhe der Behälter beinhaltet die Füße H2 cm. Nach Wahl des Kunden und gegen Aufpreis können die Behälter auch zu den H2 cm-Füßen mit einem Metallboden ausgestattet werden. Die Basis sind in zwei Modellen (MCM und MD) und zwei Höhen (H16 und H32 cm) erhältlich.

La altura de los aparadores indicada en la tarifa incluye los pies de 2 cm de altura. Bajo pedido y con un suplemento de precio, los aparadores pueden montar una base metálica en alternativa a los pies de 2 cm. Las bases están disponibles en dos modelos (MCM y MD) y dos alturas: 16 y 32 cm.

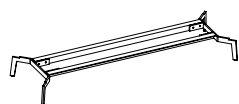

BASE MCM / H16 cm MID-CENTURY MODERN

Metallo brunito vintage
Vintage burnished metal
Métal bruni vintage
Vintage brüniertes Metall
Metal bruñido vintage

(page / Seite 00)

Anish / ComRi / Polka Dots	128 cm	BMCM128BV
Carlos / Leon / Spectro	144 cm	BMCM144BV
Anish / Carlos / ComRi Leon / Not Riddled / Polka Dots Riddled Front / Spectro / Tide	192 cm	BMCM192BV
Carlos / Leon / Spectro	240 cm	BMCM240BV

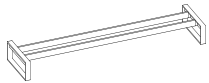

BASE MD / H16 cm
MINIMAL DESIGN

Nero Black Noir Schwarz Negro RAL 9011	Bianco White Blanc Weiß Blanco RAL 9016
---	--

Anish / ComRì / Polka Dots	128 cm	IB51ZZ1	IB51BB1
Carlos / Leon / Spectro	144 cm	IB51ZZ	IB52BB
Anish / Carlos / ComRì Leon / Not Riddled / Polka Dots Riddled Front / Spectro / Tide	192 cm	IB71ZZ	IB71BB
Carlos / Leon / Spectro	240 cm	IB81ZZ	IB81BB



BASE MD / H32 cm
MINIMAL DESIGN

Nero Black Noir Schwarz Negro RAL 9011	Bianco White Blanc Weiß Blanco RAL 9016
---	--

Anish / ComRì / Polka Dots	128 cm	IB52ZZ1	IB52BB1
Carlos / Leon / Spectro	144 cm	IB52ZZ	IB52BB
Anish / Carlos / ComRì Leon / Not Riddled / Polka Dots Riddled Front / Spectro / Tide	192 cm	IB72ZZ	IB72BB
Carlos / Leon / Spectro	240 cm	IB82ZZ	IB82BB