



CASAMANIA
HORM

Beds, Sofa Beds, and Figi Island

Awards



2008 / Stand Salone 2005
2004 / Ripples
1998 / Istruzioni di montaggio



2016 / Autoreggente
2011 / Bek
2008 / Tide

2001 / Sottiletto
1998 / Wow! Plus
1998 / Take

1994 / Tola



2014 / Autoreggente
2013 / Infinity
2011 / RememberMe

2008 / N7



2014 / Toshi
2013 / Lepel
2013 / Chariot



2016 / QuaDror™ 03



2012 / Maritime



2016 / Tout le Jour



2016 / Torii



2010 / Lieve
2007 / A/R



2016 / Torii
2015 / Autoreggente
2013 / Chariot
2011 / Sinapsi

2008 / Bek
2008 / A/R
2007 / Blend
2007 / Tide

2006 / Stand Salone 2005
2004 / Ripples
1999 / Sottiletto

Home & Contract

Gli opposti si attraggono. HORM e CASAMANIA hanno da sempre due anime distinte, intrise di pura passione per la ricerca, la qualità, il design. Questo Catalogo rappresenta l'inizio di un progetto: far dialogare questi pluridecennali campioni del Made in Italy, nel solco della loro identità. Horm è lo stile più rigoroso, formale, elegante, caratterizzato dal sapiente uso delle materie pure come il legno, la pietra, il marmo, il vetro. Casamania gioca da sempre con l'ironia, l'irriverenza formale, la voglia di rompere gli schemi nel segno della funzionalità e della ricerca. La prima è sempre stata e continuerà ad essere un'icona di stile e di raffinata eleganza in ambito HOME; la seconda è un modello per il mercato CONTRACT. Tuttavia gli opposti si attraggono, si fondono e si moltiplicano, offrendo infinite soluzioni di stile, di utilizzo, di collocazione. Due identità che unite vogliono rompere le rigide barriere del mercato, ponendo al centro del progetto l'Uomo nelle sue molteplici attività: pensare, sedersi, riposare, mangiare, lavorare, studiare, giocare, dormire, amare, sognare, conversare. Horm e Casamania: Home & Contract.

Vol. 01
Sedute, Tavoli e Tavolini

Vol. 02
Contenitori, Mensole e Librerie

Vol. 03
Complementi, Illuminazione e Outdoor

Vol. 04
Letti, Divani Letto e Isole Figli

Vol. 05
Divani

Opposites attract. HORM and CASAMANIA have always had two different souls, imbued with a pure passion for research, quality and design. This catalogue represents the starting point of a new project: to make these historical champions of the Made in Italy production talk to each other, in the wake of their identity. Horm is the most rigorous, formal, elegant style, characterised by the skilful use of pure materials, such as wood, stone, marble and glass. Casamania has always played with irony, formal irreverence, the desire to break the mould in the name of functionality and research. The first has always been and will continue being an icon of style and refined elegance in the HOME, the second a model for the CONTRACT market. However, opposites attract, merge and multiply, offering infinite solutions of style, use and arrangement. Two identities that together want to break the rigid barriers of the market, placing People in its many activities at the heart of the project: thinking, sitting, resting, eating, working, studying, playing, sleeping, loving, dreaming, talking. Horm and Casamania: Home & Contract.

Vol. 01
Chairs, Tables, and Low Tables

Vol. 02
Storage and Shelving Solutions

Vol. 03
Furnishing Accessories,
Lighting, and Outdoor

Vol. 04
Beds, Sofa Beds, and Figi Islands

Vol. 05
Sofas and Armchairs

Les opposés s'attirent. HORM et CASAMANIA ont toujours eu deux âmes distinctes, imprégnées d'une pure passion pour la recherche, la qualité et le design. Ce catalogue représente le début d'un projet: faire dialoguer ces pluridécennales champions du Made in Italy, dans la lignée de leur identité. Horm représente un style plus rigoureux, formel, élégant, caractérisé par une utilisation habile des matériaux purs comme le bois, la pierre, le marbre et le verre. Casamania a toujours joué avec l'ironie, l'irrévérence formelle, le désir de briser les schémas sous le signe de la fonctionnalité et de la recherche. La première a toujours été et continuera à être une icône de style et d'élégance raffinée dans le domaine HOME, la seconde est un modèle pour le marché CONTRACT. Cependant, les opposés s'attirent, fusionnent et se multiplient, en offrant des solutions infinies de style, d'utilisation et d'emplacement. Deux identités qui, ensemble, veulent briser les rigides barrières du marché, en plaçant l'Homme dans ses nombreuses activités au centre du projet: penser, s'asseoir, se reposer, manger, travailler, étudier, jouer, dormir, aimer, rêver, converser. Horm et Casamania: Home & Contract.

Vol. 01
Chaises, Tables et Tables Basses

Vol. 02
Meubles de rangement, Etagères et Bibliothèques

Vol. 03
Compléments d'ameublement,
Luminaire et Outdoor

Vol. 04
Lits, Canapés-lits et Îles Figi

Vol. 05
Canapés et Fauteuils

Gegensätze ziehen sich an. HORM und CASAMANIA hatten schon immer zwei verschiedene Seelen, durchdrungen von einer reinen Leidenschaft für Forschung, Qualität und Design. Dieser Katalog stellt den Beginn eines Projekts dar: diese jahrzehntelangen Meister des Made in Italy im Zuge ihrer Identität miteinander in Dialog zu bringen. Horm ist der rigoroseste, formalste und eleganteste Stil, der sich durch den geschickten Einsatz von reinen Materialien wie Holz, Stein, Marmor und Glas auszeichnet. Casamania setzte schon immer auf Ironie, formale Respektlosigkeit und den Wunsch, diese Klischees im Namen der Funktionalität und Forschung durchzubrechen. Die erste war und ist eine Ikone des Stils und der raffinierten Eleganz im Bereich HOME, die zweite ein Modell für den CONTRACT-Markt. Gegensätze ziehen sich jedoch an, verschmelzen und multiplizieren sich und bieten unendliche Lösungen für Stil, Nutzung und Anordnung. Zwei Identitäten, die gemeinsam die starren Barrieren des Marktes überwinden wollen, indem sie den Menschen in den Mittelpunkt des Projekts stellen: Denken, Sitzen, Ausruhen, Essen, Arbeiten, Studieren, Spielen, Schlafen, Lieben, Träumen, Sprechen. Horm und Casamania: Home & Contract.

Vol. 01
Stühle, Tische, Couch- und Beistelltische

Vol. 02
Sideboards, Wandregale und Bücherregale

Vol. 03
Kleinformel, Accessoires,
Lampen und Outdoor

Vol. 04
Betten, Bettsofas und Figi-Inseln

Vol. 05
Sofas und Sessel

Los opuestos se atraen. HORM y CASAMANIA siempre han tenido dos almas distintas, imbuidas de pura pasión por la investigación, la calidad y el diseño. Este catálogo representa el comienzo de un proyecto: un diálogo entre estos campeones del Made in Italy, partiendo de la identidad de cada uno de ellos. Horm es el estilo más riguroso, formal y elegante, caracterizado por un uso hábil de materiales puros como la madera, la piedra, el mármol y el vidrio. Casamania siempre ha jugado con la ironía, la irreverencia formal, el deseo de romper moldes en aras de la funcionalidad y la investigación. La primera ha sido siempre y lo seguirá siendo un icono de estilo y refinada elegancia en el ámbito HOME, la segunda es un referente del mercado CONTRACT. Sin embargo, los opuestos se atraen, se fusionan y se multiplican, aportando infinitas soluciones de estilo, uso y ubicación. Dos identidades que quieren romper juntas las rígidas barreras del mercado, colocando en el centro del proyecto al Ser Humano en sus múltiples actividades: pensar, sentarse, descansar, comer, trabajar, estudiar, jugar, dormir, amar, soñar, conversar. Horm y Casamania: Home & Contract.

Vol. 01
Sillas, Mesas y Mesitas

Vol. 02
Aparadores, Estanterías y Librerías

Vol. 03
Complementos de decoración,
Iluminación y Outdoor

Vol. 04
Camas, Sofás Cama e Islas Figi

Vol. 05
Sofás y Sillones

Designers



Baldanzi
& Novelli



Claudio
Bellini



Mario
Bellini



Patrizia
Bertolini



Mario
Botta



Burtcher
& Bertolini



Enrico
Cesana



Claesson
Koivisto
Rune



Carlo
Cumini



Maarten
De Ceulaer



Joe
Doucet



Dror



D'Urbino
Lomazzi



Sebastian
Errazuriz



Fabrica

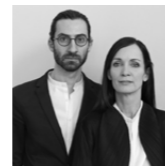

GamFratesi



Daniele
Gaspardo



Jean Francois
Gornée



Grafite
Design



Harry
& Camila



Steven
Holl



Benjamin
Hubert



Giulio
Iacchetti



Salvatore
Indriolo



Toyo
Ito

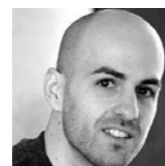

Tobias
Jurczek



LucidiPevere



Giulio
Manzoni



Ilaria
Marelli



Menguzzato
& Nascimben



Neuland,
Paster &
Geldmacher



Luca
Nichetto



Fabio
Novembre



Orlandini
Design



Josh
Owen



Palomba
Serafini
Associati



Pastorino
& Suarez



Jake
Phipps



Marcello
Pozzi



Meneghello
Paoletti
Associati



Pudelskern



Karim
Rashid



Carlo
Stefanut



Stokkeastad



Studio 63



Studio
Balutto



Studio
Habits



Marta
Szymkowiak



Marc
Thorpe



Matteo Thun
& Antonio
Rodriguez



Esa
Vesmanen



Samuel
Wilkinson



Wis
Design



Sean
Yoo



Renato
Zamberlan



StH
Orizzonti
Design
Center

028, 030	Andaman	052»056	Milos
024, 026	Bahamas Alto <i>Legno</i>	044»048	Moheli
024	Bahamas Basso <i>Legno</i>	050	Moheli Baldacchino
020, 022	Bahamas <i>Mid-Century</i>	044	Moheli Sommier
110, 112	Bali	014	Nest
032	Capri <i>Legno</i>	076, 078	Panarea
034	Capri <i>Mid-Century</i>	076	Panarea Sommier
016	Ebridi <i>Legno</i>	120»124	Samoa
018	Ebridi <i>Mid-Century</i>	084, 086	Sardegna
016	Ebridi Sommier <i>Legno</i>	084, 088	Sardegna Sommier
009	Ebridi Sommier <i>Mid-Century</i>	040, 042	Sottiletto
102	Elba	042	Sottiletto Sommier
104	Elba Plus	062»068	Tahiti
138	Figi Isola	066	Tahiti High
138	Figi Isoletto	062	Tahiti Sommier
138	Figi Isoleuse	080, 082	Tasca
134»138	Figi Isolina	080	Tasca Sommier
138	Figi Isolino	036	Twine Sommier
136, 138	Figi Isolona	036, 038	Twine Testiera
132, 138	Figi Isolotto	126, 128	Vulcano
096, 098	Figi Letto	058, 060	White
100	Figi Letto Estraibile	060	White High
096, 100	Figi Letto Sommier	058	White Sommier
138	Figi Mezza Isola		
138	Figi Mezza Isolina		
138	Figi Mezzo Isolino		
090	Flores		
114, 118	Gabriel Duo Isola		
116	Gabriel Duo Isoletto		
117	Gabriel Duo Isoleuse		
117	Gabriel Duo Isolina		
116	Gabriel Duo Isolino		
116	Gabriel Duo Isolona		
114, 117	Gabriel Duo Isolotto		
070, 072	Grenada		
074	Grenada High		
106	Linosa		
106	Linosa Plus		
092, 094	Lipari		
009	Lipari Estraibile		
092	Lipari Plus		

145 Letti / Schede tecniche
Beds / Technical sheets

203 Divani Letto / Schede tecniche
Sofa Beds / Technical sheets

211 Isole Figi / Schede tecniche
Figi Islands / Technical sheets

Letti singoli e matrimoniali
Single and double beds
Lits simples et doubles
Einzel- und Doppelbetten
Camas individuales y dobles



Andaman
028, 030



Bahamas Alto *Legno*
024, 026



Bahamas Basso *Legno*
024



Bahamas *Mid-Century*
020, 022



Capri *Legno*
032



Capri *Mid-Century*
034



Ebridi *Legno*
016



Ebridi *Mid-Century*
018



Elba
102



Elba Plus
104



Figi Letto
096, 098



Flores
090



Grenada
070, 072



Grenada High
074



Linosa
106



Linosa Plus
106



Lipari
092, 094



Lipari Plus
092



Milos
052, 054, 056



Moheli
044, 046, 048



Moheli Baldacchino
050



Nest
014



Panarea
076, 078



Sardegna
084, 086



Sottiletto
040, 042



Tahiti
062, 064, 068



Tahiti High
066



Tasca
080, 082



Twine
036, 038



White
058, 060



White High
060

Letti sommier
Beds without headboard
Lits sans tête de lit
Betten ohne Kopfteil
Camas sin cabecero



Ebridi Sommier *Legno*
016



Ebridi Sommier *Mid-Century*



Figi Letto Sommier
096, 100



Moheli Sommier
044



Panarea Sommier
076



Sardegna Sommier
084, 088



Sottiletto Sommier
042



Tahiti Sommier
062



Tasca Sommier
080



Twine Sommier
036



White Sommier
058

Letti con estraibile
Pull-out beds
Lits gigognes
Ausziehbare Betten
Camas extraíbles



Figi Letto Estraibile
100



Lipari Estraibile

Divani letto
Sofa beds
Canapés-lits
Bettssofas
Sofás cama



Bali
110, 112



Gabriel Duo
114, 116, 118



Samoa
120, 122, 124



Vulcano
126, 128

Isole Figi
Figi Islands
Îles Figi
Figi-Inseln
Islas Figi



Figi Isola
138



Figi Isolino
138



Figi Isolina
134, 136, 138



Figi Isoleuse
138



Figi Isoletto
138



Figi Isolona
136, 138



Figi Isolotto
132, 138



Figi Mezza Isola
138



Figi Mezzo Isolino
138



Figi Mezza Isolina
138

Letti singoli e matrimoniali
Single and double beds
Lits simples et doubles
Einzel- und Doppelbetten
Camas individuales y dobles

Nest

HORM / Enrico Cesana

» [technical info p. 184](#)

Anish Cassettiera
comò / chest of drawers
vol. 02



Ebridi Trapuntato *Legno*

HORM / Orizzonti Design Center
» [technical info p. 162](#)

Ebridi Sommier *Legno*

HORM / Orizzonti Design Center
» [technical info p. 164](#)





Ebridi Tessile Mid-Century

HORM / Orizzonti Design Center

» [technical info p. 163](#)

Network
libreria / bookcase
vol. 02

Tide Comò
comò / chest of drawers
vol. 02

O20

Bahamas *Mid-Century*

HORM / Orizzonti Design Center

» [technical info p. 159](#)



O21

HC

Bahamas *Mid-Century*

HORM / Orizzonti Design Center

» technical info p. 159

QuaDror™ 01
tavolino / side table
vol. 01

Tout le Jour Lounge
lounge / lounge chair
vol. 01



Bahamas Alto *Legno*

HORM / Orizzonti Design Center
» [technical info p. 157](#)

Bahamas Basso *Legno*

HORM / Orizzonti Design Center
» [technical info p. 158](#)



Bahamas Alto *Legno*

HORM / Orizzonti Design Center

» [technical info p. 157](#)

Leon Wood
madia / sideboard
vol. 02

Hcb
appendiabiti / coat stand
vol. 03

Andaman

HORM / Orizzonti Design Center
» [technical info p. 156](#)



Andaman

HORM / Orizzonti Design Center
» technical info p. 156



Hexagon
tavolino / side table
vol. 01

Capri *Legno*

HORM / Matteo Thun & Antonio Rodriguez, 2011

» [technical info p. 160](#)





Capri Mid-Century

HORM / Matteo Thun & Antonio Rodriguez, 2011

» [technical info p. 161](#)

Ray Sedia
sedia / chair
vol. 01

Bureau
scrivania / desk
vol. 01

Io e Te
tavolino / side table
vol. 01

Twine Sommier + Testiera

HORM / Matteo Thun & Antonio Rodriguez, 2011
» [technical info p. 196](#)

Twine Sommier

HORM / Matteo Thun & Antonio Rodriguez, 2011
» [technical info p. 196](#)



Twine Sommier + Testiera

HORM / Matteo Thun & Antonio Rodriguez, 2011

» [technical info p. 196](#)

Albino Family
tavolino / side table
vol. 01

Albino Torcia
tavolino / side table
vol. 01

Yume Black
specchio / mirror
vol. 03

Sottiletto

HORM / Burtcher & Bertolini, 1997

» [technical info p. 189](#)



Sottiletto

HORM / Burtcher & Bertolini, 1997
» [technical info p. 189](#)

Sottiletto Sommer

HORM / Burtcher & Bertolini, 1997
» [technical info p. 190](#)



Moheli

HORM / Orizzonti Design Center
» [technical info p. 181](#)

Moheli Sommer

HORM / Orizzonti Design Center
» [technical info p. 183](#)



Moheli

HORM / Orizzonti Design Center

» [technical info p. 181](#)

Albino Torcia
tavolino / side table
vol. 01

Albino Family
tavolino / side table
vol. 01

Moheli

HORM / Orizzonti Design Center

» [technical info p. 181](#)

Twist
 appendiabiti / coat stand
 vol. 03

QuaDror™ 01
 tavolino / side table
 vol. 01

Moheli Baldacchino

HORM / Orizzonti Design Center

» [technical info p. 182](#)



Lobby
poltroncina / easy chair
vol. 01

Chariot
tavolino / side table
vol. 01

Milos

HORM / Orizzonti Design Center
» [technical info p. 179](#)



Milos

HORM / Orizzonti Design Center
» [technical info p. 179](#)

Bifronte
tavolino / side table
vol. 01

ComRì
comò / chest of drawers
vol. 02

Milos

HORM / Orizzonti Design Center

» [technical info p. 179](#)

Ripples
panca / bench
vol. 01

Alma a terra
contenitore multiuso / multi-use shelf organizer
vol. 02

White Sommier

HORM / Orizzonti Design Center
» [technical info p. 200](#)



White
HORM / Orizzonti Design Center
» [technical info p. 198](#)



White

HORM / Orizzonti Design Center
» technical info p. 198

White High

HORM / Orizzonti Design Center
» technical info p. 199



Singles
libreria / bookcase
vol. 02

Bifronte
tavolino / sidetable
vol. 01

Tahiti Sommer

HORM / Renato Zamberlan, 2013
» [technical info p. 193](#)



Tahiti

HORM / Renato Zamberlan, 2013
» [technical info p. 191](#)



Tahiti

HORM / Renato Zamberlan, 2013

» [technical info p. 191](#)

Bureau
scrittoio / desk
vol. 01

Hexagon
tavolino / side table
vol. 01

Charlotte
poltroncina / easy chair
vol. 01

Ray Sedia
sedia / chair
vol. 01



Tahiti High

HORM / Renato Zamberlan, 2013
» [technical info p. 192](#)

Polka Dots
media / sideboard
vol. 02

Meduse Tavolino
tavolino / side table
vol. 01



Tahiti

HORM / Renato Zamberlan, 2013

» technical info p. 191

			
RAL 9010	RAL 1019	RAL 1011	RAL 8014
			
RAL 7043	RAL 4006	RAL 2001	RAL 3005
			
RAL 4001	RAL 1004	RAL 6002	RAL 5015
			
RAL 5013	RAL 7047	RAL 9005	RAL 3003

Colori disponibili per le cuciture
 Colors available for the stitches
 Couleurs disponibles pour les coutures
 Verfügbare Farben für die Nähte
 Colores disponibles para las costuras



Grenada

HORM / Renato Zamberlan, 2018
» [technical info p. 172](#)





Grenada

HORM / Renato Zamberlan, 2018
» [technical info p. 172](#)

Albino Family
tavolino / side table
vol. 01

Albino Torcia
tavolino / side table
vol. 01



Grenada High

HORM / Renato Zamberlan, 2018

» [technical info p. 173](#)



Albino Family
tavolino / side table
vol. 01

Giro Tavolino
tavolino / side table
vol. 01

Panarea Sommer

HORM / Orizzonti Design Center
» [technical info p. 186](#)



Panarea

HORM / Orizzonti Design Center
» [technical info p. 185](#)



Panarea

HORM / Orizzonti Design Center

» technical info p. 185



Chariot
tavolino / side table
vol. 01

Solaio Armadio
armadio / wardrobe
vol. 02

Cobra
porta tv / tv stand
vol. 03

Tasca Sommer

HORM / Studio Habits
» [technical info p. 195](#)



Tasca

HORM / Studio Habits
» [technical info p. 194](#)



Tasca

HORM / Studio Habits

» technical info p. 194

Bifronte
tavolino / side table
vol. 01

Twist
appendiabiti / coat stand
vol. 03

ComRi
madia / sideboard
vol. 02

Sardegna

HORM / Orizzonti Design Center
» [technical info p. 187](#)

Sardegna Sommier

HORM / Orizzonti Design Center
» [technical info p. 188](#)



Sardegna

HORM / Orizzonti Design Center
» [technical info p. 187](#)

Chariot
tavolino / side table
vol. 01



Sardegna Sommier

HORM / Orizzonti Design Center
» [technical info p. 188](#)



Flores

HORM / Orizzonti Design Center
» [technical info p. 171](#)



Albino Family
tavolino / side table
vol. 01

Sudoku
libreria / bookcase
vol. 02

Lipari Plus

HORM / Orizzonti Design Center
» technical info p. 178

Lipari

HORM / Orizzonti Design Center
» technical info p. 176



Twine Tavolino
tavolino / side table
vol. 01



Lipari

HORM / Orizzonti Design Center

» [technical info p. 176](#)

Bifronte
tavolino / side table
vol. 01

Figi Letto Sommier

HORM / Orizzonti Design Center
» [technical info p. 170](#)



Figi Letto

HORM / Orizzonti Design Center
» [technical info p. 168](#)



Figi Letto

HORM / Orizzonti Design Center

» [technical info p. 168](#)

Twine Tavolino
tavolino / side table
vol. 01

Yume
specchio / mirror
vol. 03

Twist
appendiabiti / coat stand
vol. 03

Charlotte
poltroncina / easy chair
vol. 01

Figi Letto Sommier + Testiera Large

HORM / Orizzonti Design Center
» technical info p. 170 + 201

Figi Letto Estraibile

HORM / Orizzonti Design Center
» technical info p. 169



ComRi
media / sideboard
vol. 02



Elba

HORM / Orizzonti Design Center
» [technical info p. 166](#)



Elba Plus

HORM / Orizzonti Design Center

» [technical info p. 167](#)

Numero 3
lampada / lamp
vol. 03

Albino Torcia
tavolino / side table
vol. 01

Linosa Plus

HORM / Orizzonti Design Center
» technical info p. 175

Linosa

HORM / Orizzonti Design Center
» technical info p. 174



Yume Black
specchio / mirror
vol. 03

Lily
tavolino / side table
vol. 01



Divani letto
Sofa beds
Canapés-lits
Bettsofas
Sofás Cama

Bali

HORM / Giulio Manzoni
» technical info p. 204



Singles
libreria / bookcase
vol. 02

Albino Family
tavolino / coffee table
vol. 01



Bali

HORM / Giulio Manzoni
 » [technical info p. 204](#)

Sistema di apertura
 Opening system
 Système d'ouverture
 Eröffnungssystem
 Sistema de apertura



Gabriel Duo Isootto

HORM / Giulio Manzoni

» technical info p. 206



Lily
tavolino / coffee and side table
vol. 01

Gabriel Duo

HORM / Giulio Manzoni
» [technical info p. 206](#)

Varianti
Variants
Variantes
Varianten
Variantes



Gabriel Duo

HORM / Giulio Manzoni

» [technical info p. 206](#)

Sistema di apertura
Opening system
Système d'ouverture
Eröffnungssystem
Sistema de apertura





Samoa Large

HORM / Giulio Manzoni
» [technical info p. 208](#)

Solaio
libreria / bookcase
vol. 02

Giro Tavolino
tavolino / coffee table
vol. 01

Xx
appendiabiti / coat stand
vol. 03





Samoa Slim

HORM / Giulio Manzoni

» [technical info p. 208](#)

Twine Tavolino
tavolino / coffee table
vol. 01

Samoa

HORM / Giulio Manzoni

» [technical info p. 208](#)

Varianti e Sistema di apertura
 Variants and Opening system
 Variantes et Système d'ouverture
 Varianten und Eröffnungssystem
 Variantes y Sistema de apertura



Vulcano

HORM / Giulio Manzoni
 » technical info p. 209

Yume Black
 specchio / mirror
 vol. 03

Albino Family
 tavolino / side table
 vol. 01

Albino Torcia
 tavolino / side table
 vol. 01

Vulcano

HORM / Giulio Manzoni

» [technical info p. 209](#)

Sistema di apertura
Opening system
Système d'ouverture
Eröffnungssystem
Sistema de apertura



Isole Figi
Fiji Islands
Îles Figi
Fiji-Inseln
Islas Figi

Figi Isolotto

HORM / Orizzonti Design Center

» technical info p. 212



Blend
armadio / wardrobe
vol. 02

Figi Isolina

HORM / Orizzonti Design Center

» [technical info p. 212](#)

Ray Sedia
sedia / chair
vol. 01

Bureau
scrittolo / desk
vol. 01

Woodlock
orologio / clock
vol. 03

Albino Torcia
tavolino / side table
vol. 01



Figi Isolina + Figi Isolona

HORM / Orizzonti Design Center

» [technical info p. 212](#)

Numero 3
lampada da terra / floor lamp
vol. 03

Albino Family
tavolino / coffee table
vol. 01



1. Isolina

Varianti
Variants
Variantes
Varianten
Variantes



4. Isoletto



5. Isolona



6. Isoleuse



7. Isolotto



2. Isola



3. Isolino



8. Mezza Isola



9. Mezzo Isolino



10. Mezza Isolina



1. Figi 98

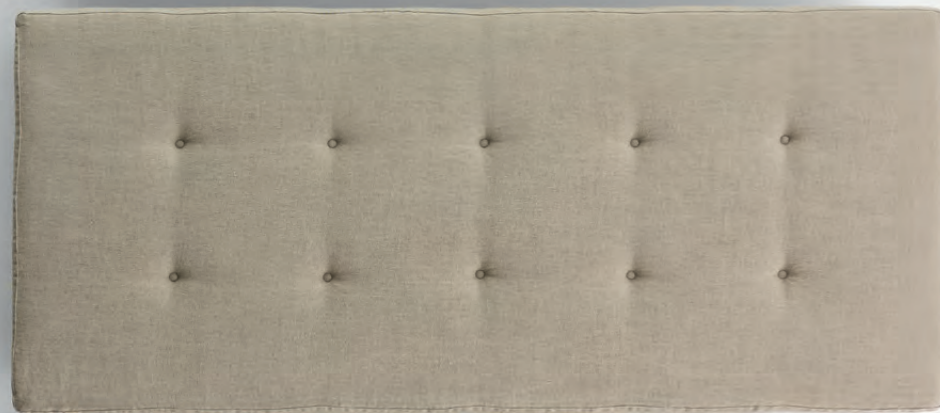

2. Figi 88



3. Figi Compact

Dimensioni
Sizes
Dimensions
Größe
Medidas

Modelli
Models
Modèles
Modelle
Versiones

- 4. Fixed
Fixe
Fest
Fijo
- 5. Storage
Lit coffre
Aufklappbar
Canapé arcón
- 6. Pull-out
Lit gigogne
Ausziehbar
Canapé nido



4. Fisso



5. Contenitore



6a. Estraibile



6b. Estraibile



6c. Estraibile



1. Seduta senza bottoni



2. Seduta con bottoni

Cuscino di seduta
Cushion seat
Cousin d'assise
Kissen-Sitz
Asiento del sofa

Accessori e piedini
Accessories and feet
Accessoires et pieds
Accessorios und Füße
Accesorios y patas



4. Schienali imbottiti



5. Cuscini e rulli

1. Seat without buttons
Assise sans boutons
Sitz ohne Knöpfe
Asiento sin botones
2. Seat with buttons
Assise avec des boutons
Sitz mit Knöpfen
Asiento con botones
3. Mattress + Bedspread
Matelas + Couvre-lit
Matratze + Tagesdecke
Colchón + Cobertor

4. Padded backrests
Dossiers rembourrés
Gepolsterte Rückenlehnen
Respaldos acolchados
5. Cushions and bolsters
Coussins et traversins
Kissen und Kissenrollen
Cojines y cojines cilindricos
6. White
Blanc
Weiß
Blanco
7. Mocha
Moka
Mokka
Moca
8. Natural
Naturel
Natur
Natural
9. Walnut
Noyer
Nussbaum
Nogal



6. Bianco



7. Moca



8. Naturale



9. Noce

3. Materasso + Copriletto

Letti / Schede tecniche
Beds / Technical sheets
Lits / Fiches techniques
Betten / Technische Datenblätter
Camas / Fichas técnicas

Configurazione di serie: giroletto esterno al materasso

La configurazione di serie nei letti elencati nella nota (*) a piè di pagina prevede che la rete del letto abbia la stessa dimensione del materasso e che il giroletto sia esterno al materasso (fig. A).

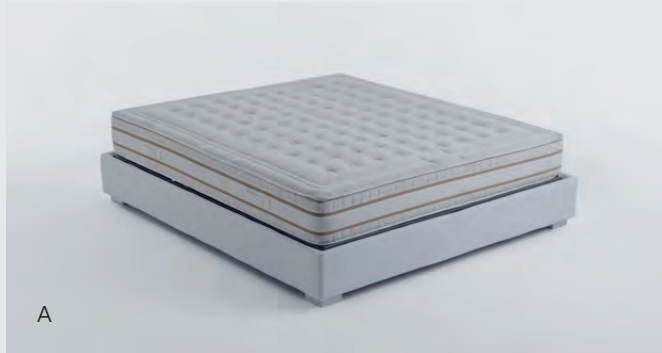

Il beneficio di questa configurazione è che la rete e il materasso possono essere incassati all'interno del giroletto (fig. B). La rete è infatti appoggiata su quattro cubotti angolari provvisti di una parte superiore (top) che durante il montaggio può essere regolata in altezza. L'incasso del materasso è possibile solo nei letti senza contenitore poichè in sua presenza, la posizione del top, per esigenze tecniche, deve essere fissa.



Standard configuration: bed frame outside the mattress

The standard configuration in the beds listed in footnote (*) requires that the slatted bed has the same size as the mattress and that the bed frame is outside the mattress (fig. A).

Configuration de série: cadre de lit à l'extérieur du matelas

La configuration de série des lits énumérés dans la note (*) de bas de page prévoit que le sommier soit de la même taille que le matelas et que le cadre du lit soit à l'extérieur du matelas (fig. A).

Standardkonfiguration: Bettrahmen außerhalb der Matratze

Die Standardkonfiguration der in der Fußnote (*) aufgeführten Betten erfordert, dass der Lattenrost die gleiche Größe wie die Matratze aufweist und dass sich der Bettrahmen außerhalb der Matratze befindet (Abb. A).

Configuración de serie: marco de la cama externo al colchón

La configuración de serie en las camas enumeradas en la nota (*) a pie de la página requiere que el somier de la cama sea del mismo tamaño que el colchón y que el marco de la cama sea externo al colchón (Fig. A).



L'avantage de cette configuration est que le sommier et le matelas peuvent être encastrés dans le cadre du lit (fig. B). Le sommier s'appuie, en effet, sur quatre supports d'angle métalliques dotés d'une partie supérieure (top) réglable en hauteur lors de l'assemblage du lit. Le matelas ne peut être encastré que dans des lits sans tiroir-rangement car sinon en sa présence la position du top pour des raisons techniques doit être fixe.

Der Vorteil dieser Konfiguration besteht darin, dass Lattenrost und Matratze in den Bettrahmen eingelassen werden können (Abb. B). Der Lattenrost wird tatsächlich auf vier Metall-Eckwinkeln aufgelegt, die mit einem Oberteil (Auflage) versehen sind, das bei der Montage des Bettes in der Höhe verstellbar ist. Die Matratze kann nur in Betten ohne Bettkasten eingelassen werden, da die Position des Oberteils bei vorhandenem Bettkasten aus technischen Gründen fest bestimmt sein muss.

La ventaja de esta configuración es que el somier y el colchón se pueden empotrar dentro del marco de la cama (Fig. B). De este modo, el somier se coloca sobre cuatro soportes de esquina en metal que disponen de una parte superior (top) que se puede ajustar en altura durante el montaje de la cama. Solo es posible encajar el colchón en camas sin arcón, puesto que con este último la posición del top debe ser fija por necesidades técnicas.



Configurazione opzionale: giroletto a filo del materasso

Su richiesta e con un supplemento prezzo, i letti elencati nella nota (**) a piè di pagina possono essere realizzati con il materasso a filo del giroletto (fig. C). In questa configurazione la rete ha una dimensione inferiore a quella del materasso, e quest'ultimo andrà parzialmente in appoggio sul giroletto. Il beneficio di questa configurazione è quello di ridurre l'ingombro totale del letto, sia in larghezza che in lunghezza, senza ridurre la dimensione del materasso.

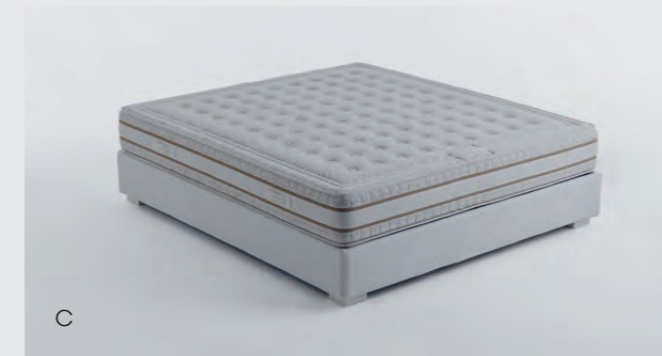

(*)

Bahamas
Elba, Elba Plus
Figi Letto, Figi Letto Sommier
Flores
Grenada, Grenada High
Linosa, Linosa Plus
Lipari, Lipari Plus
Nest
Panarea, Panarea Sommier
Sardegna, Sardegna Sommier
Tahiti, Tahiti Sommier
Tasca, Tasca Sommier
White, White High, White Sommier

Optional configuration: bed frame flush with the mattress

On request and at an additional cost, the beds listed in footnote (**) can be made with the mattress flush with the bed frame (fig. C). In this configuration, the slatted base is smaller than the mattress, and the mattress will partially rest on the bed frame. The benefit of this configuration is that it reduces the total size of the bed, both in width and length, without reducing the size of the mattress.

Configuration optionnel: cadre de lit au ras du matelas

Sur demande et moyennant un supplément de prix, les lits énumérés dans la note (**) en bas de page peuvent être réalisés avec le matelas au ras du cadre de lit (fig. C). Dans cette configuration, le sommier est plus petit que le matelas et ce dernier ne repose que partiellement sur le cadre du lit. L'avantage de cette configuration est de réduire la place totale du lit, tant en largeur qu'en longueur, sans réduire la dimension du matelas.

(**)

Bahamas
Elba, Elba Plus
Figi Letto, Figi Letto Sommier
Linosa, Linosa Plus
Lipari, Lipari Plus
Panarea, Panarea Sommier
Sardegna, Sardegna Sommier
Tahiti, Tahiti Sommier
Tasca, Tasca Sommier
White, White High, White Sommier

Optionale Konfiguration: Bettrahmen bündig zur Matratze

Auf Wunsch und gegen Aufpreis können die in der Fußnote (**) aufgeführten Betten mit der Matratze bündig zum Bettrahmen realisiert werden (Abb. C). In dieser Konfiguration ist der Lattenrost kleiner als die Matratze, und die Matratze liegt teilweise auf dem Bettrahmen auf. Der Vorteil dieser Konfiguration besteht darin, dass sie die Gesamtgröße des Bettes sowohl in der Breite als auch in der Länge reduziert, ohne die Größe der Matratze zu verringern.

Configuración opcional: marco de cama a ras del colchón

Bajo petición y con un suplemento en el precio, las camas indicadas en la nota (**) a pie de página se pueden realizar con el colchón a ras del marco (Fig. C). En esta configuración, el somier tiene medidas inferiores a las del colchón, que descansará parcialmente en el marco de la cama. La ventaja de esta configuración es la reducción del volumen total de la cama, tanto en anchura como en longitud, sin reducir el tamaño del colchón.



Dotazione di serie:
Rete a doghe

I letti sono dotati di una rete a doghe. Struttura solida e nel contempo ammortizzante. Telaio in acciaio con angoli pressofusi. 14 doghe in multistrato di faggio. 4 doghe nella zona lombo-sacrale sono regolabili in base al peso corporeo.

Standard equipment:
Slatted base

The beds are equipped with a fixed slatted frame. Solid structure and shock-absorbing at the same time. Steel frame with die-cast corners. 14 beech plywood slats. 4 slats in the lower back area are adjustable according to body weight.

Équipement de série:
Sommier à lattes

Les lits sont équipés d'un sommier à lattes fixes. Une structure solide et en même temps qui amortit. Cadre en acier avec coins moulés sous pression. 14 lattes multi-couches de hêtre. 4 lattes dans la zone lombo-sacral réglables en fonction du poids du corps.

Serienausstattung:
Lattenrost

Die Betten sind mit einem Lattenrost ausgestattet. Solide und gleichzeitig federnde Struktur. Stahlrahmen mit Druckgussecken. 14 Latten aus Buchensperrholz. 4 Latten im Lumbosakralbereich, die je nach Körpergewicht verstellbar sind.

Equipamiento de serie:
Somier de lamas

Las camas están equipadas con un somier de lamas fijas. Estructura sólida y al mismo tiempo amortiguante. Estructura de acero con esquinas presofundidas. 14 lamas en contrachapado de haya. 4 lamas en el área lumbosacra son ajustables en función del peso corporal.

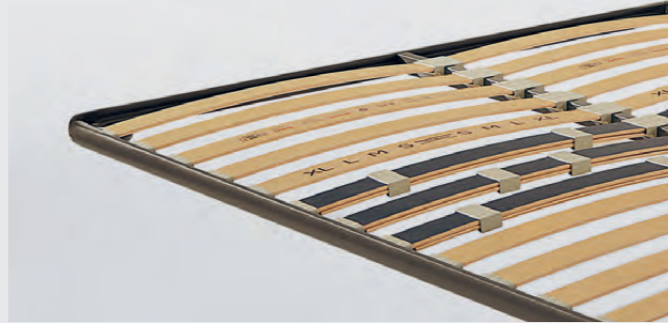
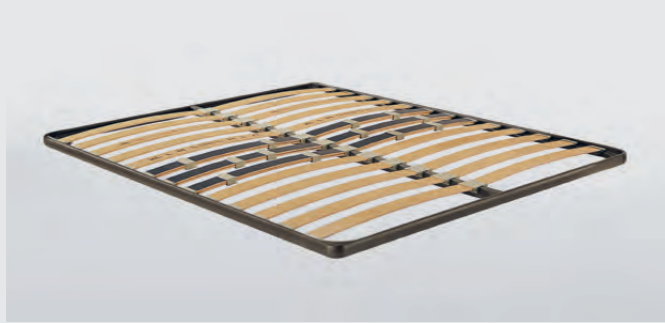

Dotazione opzionale:
Rete a doghe ammortizzate

Perfetta adattabilità alla forma del corpo. Telaio in acciaio con angoli pressofusi. 26 doghe in multistrato di faggio con regolatore di elasticità. 6 doghe nella zona lombo-sacrale sono regolabili in base al peso corporeo.

Optional equipment:
Sprung slatted base

Perfect adaptability to the shape of the body. Steel frame with die-cast corners. 26 beech plywood slats with elasticity regulator. 6 slats in the lower back area are adjustable according to body weight.

Équipement en option:
Sommier à lattes amorties

Adaptation parfaite à la forme du corps. Cadre en acier avec coins moulés sous pression. 26 lattes multi-couches de hêtre avec régulateur d'élasticité. 6 lattes dans la zone lombo-sacral réglables en fonction du poids du corps.

Optionale Ausstattung:
Gefederter Lattenrost

Perfekte Anpassung an die Form des Körpers. Stahlrahmen mit Druckgussecken. 26 Latten aus Buchensperrholz mit Regulierung der Dehnbarkeit. 6 Latten im Lumbosakralbereich, die je nach Körpergewicht verstellbar sind.

Equipamiento opcional:
somier de lamas amortiguadas

Se adapta perfectamente a la forma del cuerpo. Estructura de acero con esquinas presofundidas. 26 lamas en contrachapado de haya con regulador de elasticidad. 6 lamas en el área lumbosacra son ajustables en función del peso corporal.

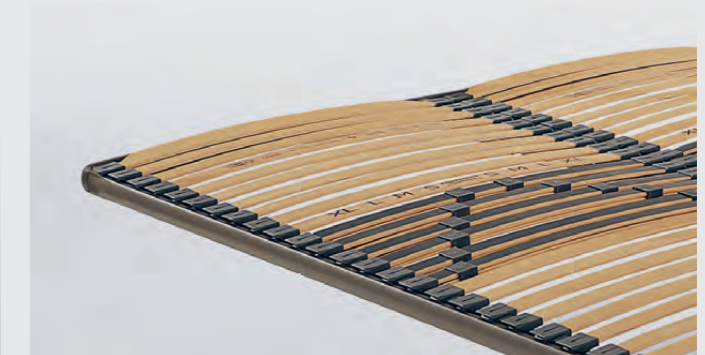
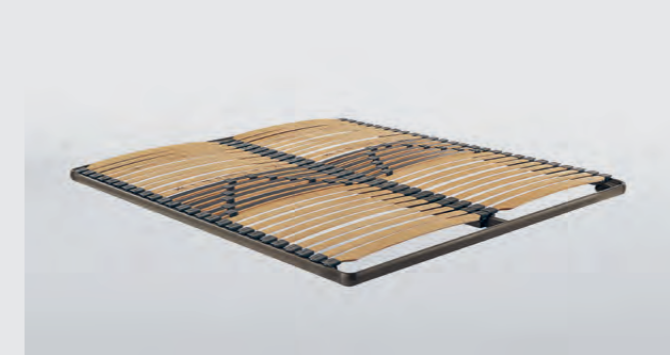

Dotazione opzionale:
Piano ortopedico

Per chi necessita di un supporto rigido uniforme. Telaio in acciaio con angoli pressofusi. Piano in multistrato di legno naturale non verniciato con fessure per la perfetta aereazione del materasso.

Optional equipment:
Orthopaedic table

For those who need uniform rigid support. Steel frame with die-cast corners. Top in unpainted natural plywood with slots for perfect mattress aeration.

Équipement en option:
Plateau orthopédique

Pour ceux qui ont besoin d'un support rigide uniforme. Cadre en acier avec coins moulés sous pression. Plateau multi-couches en bois naturel non peint avec fessures pour une aération parfaite du matelas.

Optionale Ausstattung:
Orthopädische Platte

Für diejenigen, die eine einheitliche feste Unterlage benötigen. Stahlrahmen mit Druckgussecken. Platte aus unlackiertem Natursperrholz mit Schlitz für eine perfekte Matratzenbelüftung.

Equipamiento opcional:
Somier ortopédico

Para quienes necesitan un apoyo rígido uniforme. Estructura de acero con esquinas presofundidas. Superficie en contrachapado de madera natural sin pintar con ranuras para una perfecta ventilación del colchón.

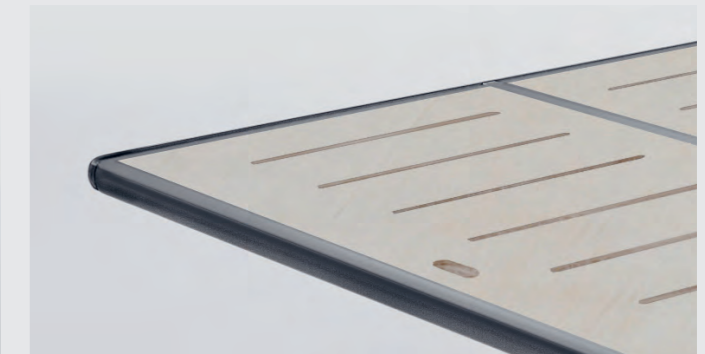
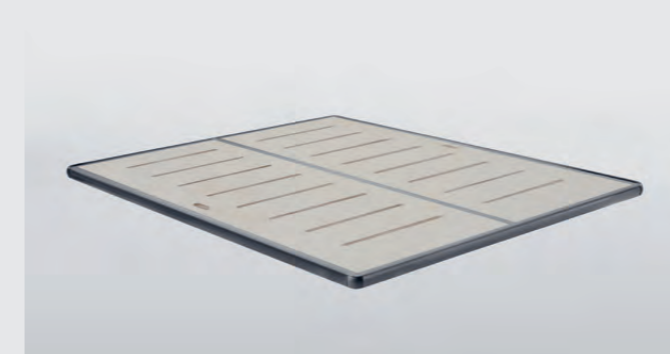

Dotazione opzionale:
Rete in legno
amagnetica

Pregio estetico unito alle proprietà naturali del legno. Priva di significative parti metalliche. 24 doghe in multistrato di faggio con regolatore di elasticità. 6 doghe nella zona lombo-sacrale sono regolabili in base al peso corporeo. Nella zona spalle sono inseriti dei piattelli che offrono flessibilità a 360° per un adattamento ideale alla postura del corpo.

Optional equipment:
Non-magnetic
wood frame

Aesthetic value combined with the natural properties of wood. Free of significant metal parts. 24 beech plywood slats with elasticity regulator. 6 slats in the lower back area are adjustable according to body weight. In the shoulder area, there are plates that offer 360° flexibility for ideal adaptation to the body's posture.

Équipement en option:
Sommier en bois non
magnétique

L'attrait esthétique combiné aux propriétés naturelles du bois. Sans pièces métalliques importantes. 24 lattes multi-couches de hêtre avec régulateur d'élasticité. 6 lattes dans la zone lombo-sacral réglables en fonction du poids du corps. Des plateaux offrant une flexibilité à 360° sont insérés dans la zone de l'épaule pour s'adapter idéalement à la posture du corps.

Optionale Ausstattung:
Nicht-magnetischer
holzrahmen Lattenrost

Ästhetischer Wert in Kombination mit den natürlichen Holzeigenschaften. Frei von bedeutenden Metallteilen. 24 Latten aus Buchensperrholz mit Regulierung der Dehnbarkeit. 6 Latten im Lumbosakralbereich, die je nach Körpergewicht verstellbar sind. Im Schulterbereich sind Scheiben angeordnet, die eine 360°-Flexibilität für eine perfekte Körperhaltung bieten.

Equipamiento opcional:
Somier en madera
no magnética

Atractiva estética unida a las propiedades naturales de la madera. Sin piezas metálicas relevantes. 24 lamas en contrachapado de haya con regulador de elasticidad. 6 lamas en el área lumbosacra son ajustables en función del peso corporal. En el área del hombro hay algunas placas que ofrecen una flexibilidad de 360° para una óptima adaptación a la postura del cuerpo.

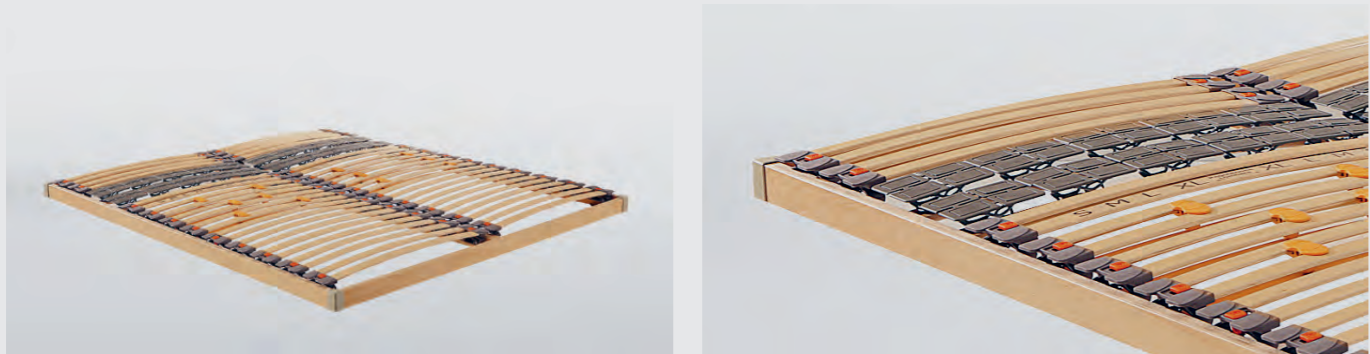

Dotazione opzionale:
Rete motorizzata
solo testa

Per un letto funzionale, non solo per dormire. Stesse caratteristiche della rete amagnetica, con l'aggiunta della motorizzazione elettrica nella zona spalle/testa. Ottimale per chi soffre di reflusso gastrico.

Optional equipment:
Electric adjustable
base, head area only

For a functional bed, not just for sleeping. Same characteristics as the non-magnetic frame, with the addition of electronic motorisation in the shoulder/head area. Ideal for those suffering from gastric reflux.

Équipement en option:
Sommier motorisé
uniquement pour la tête

Pour un lit fonctionnel, pas uniquement pour dormir. Mêmes caractéristiques que le sommier non-magnétique, avec l'ajout d'un moteur électrique dans la région épaule/tête. Idéal pour les personnes souffrant de reflux gastrique.

Optionale Ausstattung:
Lattenrost mit
motorischem Kopfteil

Für ein Funktionsbett, das nicht nur zum Schlafen dient. Verfügt über dieselben Eigenschaften wie der nicht-magnetische Lattenrost, zuzüglich eines elektrisch einstellbaren Schulter-/Kopfteil. Ideal für Menschen, die an Reflux-Beschwerden leiden.

Equipamiento opcional:
Somier motorizado
solo en la cabecera

Para una cama funcional, que no solo sirve para dormir. Mismas características del somier amagnético con la adición de un motor eléctrico en la zona de hombros/cabecera. Óptimo para quienes padecen reflujo gástrico.

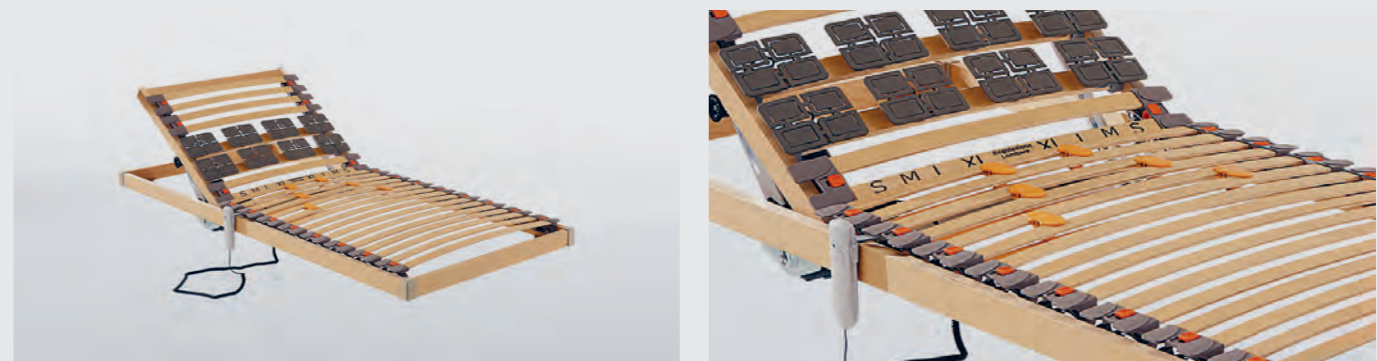

Dotazione opzionale:
Rete motorizzata
testa / piedi

La rete che segue ogni vostro movimento "a comando." Stesse caratteristiche della rete amagnetica, con due motorizzazioni elettriche indipendenti: nella zona testa per chi soffre di reflusso gastrico e nella zona piedi per agevolare la circolazione sanguigna.

Optional equipment:
Electric adjustable
base, head / foot area

The frame that follows every movement of the body "on command." The same features as the non-magnetic frame, with two independent electronic motors: in the head area for those suffering from gastric reflux and in the foot area to facilitate blood circulation.

Équipement en option:
Sommier motorisé
tête / pieds

Le sommier qui suit chaque mouvement du corps "sur commande." Mêmes caractéristiques que le sommier non magnétique, avec deux moteurs électriques indépendants: au niveau de la tête pour les personnes souffrant de reflux gastrique et au niveau des pieds pour faciliter la circulation sanguine.

Optionale Ausstattung:
Lattenrost
mit motorischem
Kopf- / Fußteil

Der Lattenrost, der jeder Bewegung des Körpers "auf Befehl" folgt. Dieselben Eigenschaften wie der nicht-magnetische Lattenrost, jedoch mit zwei unabhängigen elektrischen Antrieben: im Kopfbereich für Menschen, die an Reflux-Beschwerden leiden und im Fußbereich zur urchblutungsförderung.

Equipamiento opcional:
Somier motorizado
cabezal / pies

El somier que sigue cada movimiento del cuerpo "a la orden." Las mismas características del somier no magnético, con dos motorizaciones eléctricas independientes: en la zona de cabecera para quienes padecen reflujo gástrico y en la zona de pies para facilitar la circulación sanguínea.

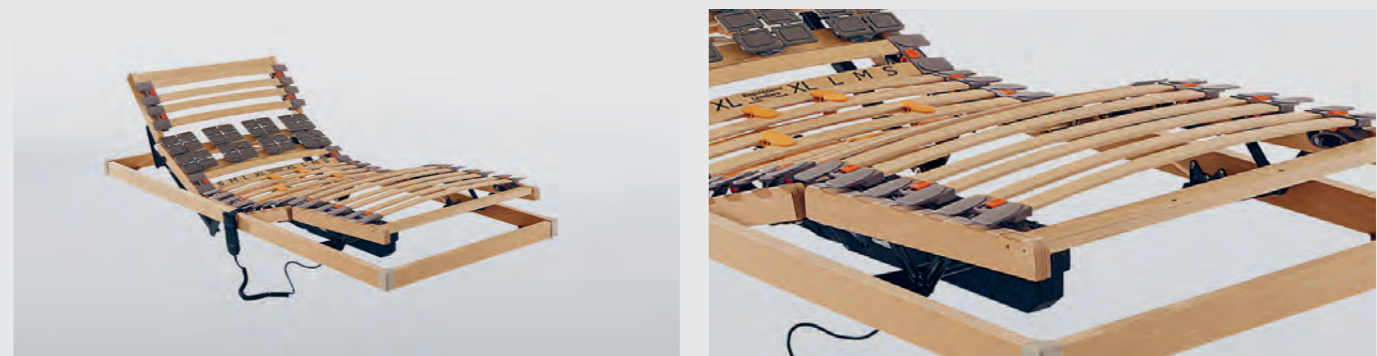

Dotazione opzionale:
Rete alzabile
con contenitore

Su richiesta e con un supplemento prezzo, i letti elencati nella nota (*) a piè di pagina possono essere dotati di una rete alzante con contenitore. La rete si alza in due posizioni: 1. inclinata (fig. A) per accedere allo spazio di contenimento; 2. orizzontale (fig. B) per permettere un semplice rifacimento del letto senza chinarsi.

Optional equipment:
Lifttable frame
with container

On request and at an additional cost, the beds listed in footnote (*) can be equipped with a lifttable slatted base with a container underneath. The base rises in two positions: 1. inclined (fig. A) to access the containment space; 2. horizontal (Fig. B) to allow for a simple remaking of the bed without bending.

Équipement en option:
Sommier relevable avec
rangement

Sur demande et moyennant un supplément de prix, les lits mentionnés dans la note (*) de bas de page peuvent être équipés d'un sommier relevable avec rangement en dessous. Le sommier se lève dans deux positions: 1. inclinée (fig. A) pour accéder à l'espace de rangement; 2. horizontale (fig. B) pour pouvoir faire facilement le lit sans se pencher.

Optionale Ausstattung:
Anhebbarer Lattenrost
mit Bettkasten

Auf Wunsch und gegen Aufpreis können die in der Fußnote (*) aufgeführten Betten mit einem anhebbaaren Lattenrost mit darunterliegendem Bettkasten ausgestattet werden. Der Lattenrost kann in zwei Positionen angehoben werden: 1. geneigt (Abb. A), um auf den Bettkasten zugreifen zu können; 2. horizontal (Abb. B), um das Bettenmachen zu erleichtern, ohne sich beugen zu müssen.

Equipamiento opcional:
Somier elevable
con arcón

Bajo petición y con un suplemento en el precio, las camas que se indican en la nota (*) a pie de página se pueden equipar con un somier elevable con arcón inferior. El somier se levanta en dos posiciones: 1. inclinada (Fig. A) para acceder al espacio de almacenamiento; 2. horizontal (Fig. B) para permitir hacer la cama con facilidad y sin inclinarse.

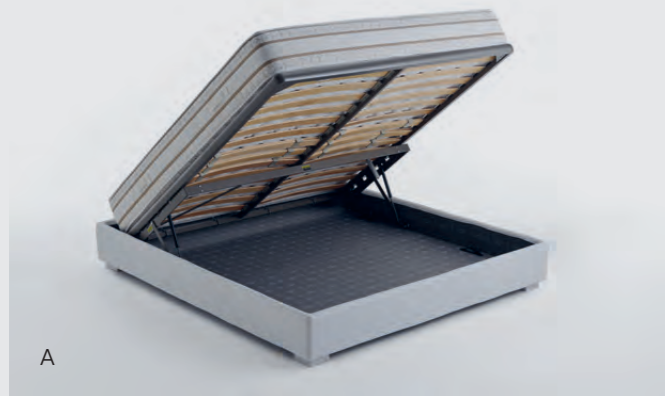

A



B



B

Nota (*)

Bahamas
Elba
Figi Letto
Flores
Grenada
Linosa
Lipari
Milos
Nest
Panarea
Sardegna
Tahiti
Tasca
White

Dotazione di serie:
Piedini di legno

I piedini di legno sono disponibili in quattro finiture, con l'esclusione del letto Sardegna, per il quale sono disponibili solo in finitura noce.

Standard equipment:
Wooden legs

The wooden legs are available in four finishes, with the exception of the Sardegna bed, where feet are available only in walnut finish.

Équipement de série:
Pieds en bois

Les pieds en bois sont disponibles en quatre finitions, à l'exception du lit Sardegna, pour lequel sont disponibles seulement en finition noyer.

Serienausstattung:
Holzfüße

Die Holzfüße sind in vier Ausführungen erhältlich, mit Ausnahme des Bettes Sardegna, das nur in Nussbaumausführung erhältlich ist.

Equipamiento de serie:
Patas de madera

Las patas de madera están disponibles en cuatro acabados, con la excepción de la cama Sardegna, que sólo está disponible en acabado nogal.



Bianco / White



Moca / Mocha



Naturale / Natural



Noce / Walnut

Tipo di rivestimento:
Velcrato

Rivestimento teso, aderente al giroletto, fissato nella parte superiore e nella parte inferiore tramite velcro. Piedini a vista.

Type of cover:
Velcro

Taut cover, adherent to the bed frame, attached at the top and at the bottom with Velcro. Visible feet.

Type de revêtement:
Velcro

Revêtement tendu, adhérent au cadre de lit, fixé dans la partie supérieure et inférieure par un velcro. Pieds visibles.

Art des Bezuges:
Klettverschluss

Gespannter und am Bettrahmen haftender Bezug, der im oberen und unteren Bereich mit Klettverschluss befestigt ist. Sichtbare Bettfüße.

Tipo de revestimiento:
Velcro

Revestimiento tensado, que se adhiere al marco de la cama, fijado a las partes superior e inferior mediante velcro. Patas a la vista.



Tipo di rivestimento:
Libero

Rivestimento teso, aderente al giroletto tramite velcro posto esclusivamente nella parte superiore. Nella parte inferiore, finitura con orlo, libera, in modo da dare una certa morbidezza poco accentuata. Piedini non a vista.

Type of cover:
Smooth

Soft cover, adhering to the bed frame with Velcro, placed exclusively at the top. The lower part has a clear hem finishing, so as to give a certain, slightly marked, softness. Invisible feet.

Type de revêtement:
Libre

Revêtement tendu, adhérent au cadre de lit par un velcro placé uniquement dans la partie supérieure. Dans la partie inférieure, finition avec ourlet, libre, de façon à donner un certain moelleux peu accentué. Pieds cachés.

Art des Bezuges:
Frei

Gespannter Bezug, ausschließlich im oberen Bereich mit Klettverschluss am Bettrahmen befestigt. Im unteren Bereich ein Abschluss mit freiliegendem Saum, um eine gewisse, wenig betonte Weichheit zu verleihen. Nicht sichtbare Bettfüße.

Tipo de revestimiento:
Libre

Revestimiento tensado, que se adhiere al marco de la cama mediante velcro, fijado únicamente a la parte superior. En la parte inferior, acabado en dobladillo libre, para aportar cierta blandura poco acentuada. Patas no visibles.



Tipo di rivestimento:
Fondo piega

Rivestimento morbido, aderente al giroletto tramite velcro posto esclusivamente nella parte superiore. Pieghe dislocate in numero variabile sul rivestimento, in modo da enfatizzarne la morbidezza. Con la pelle la finitura fondo piega non è disponibile. Piedini non a vista.

Type of cover:
Pleated corners

Soft covering, adhering to the bed frame with Velcro, placed exclusively at the top. Several folds spread on the covering, in order to emphasise the softness. The pleated corners cover is not available in leather. Invisible feet.

Type de revêtement:
Plissé

Revêtement mou, adhérent au cadre de lit par un velcro placé uniquement dans la partie supérieure. Plis disposés en nombre variable sur le revêtement, afin d'en souligner le moelleux. La finition plissé n'est pas disponible avec le cuir. Pieds cachés.

Art des Bezuges:
Bodenfalte

Weicher Bezug, der mit einem Klettverschluss ausschließlich im oberen Bereich am Bettrahmen befestigt ist. Auf dem Bezug sind Falten in variabler Anzahl angeordnet, um ihre Weichheit zu betonen. In der Ausführung mit Lederbezug ist die Bodenfalte nicht erhältlich. Nicht sichtbare Bettfüße.

Tipo de revestimiento:
Fondo en pliegues

Revestimiento blando, que se adhiere al marco de la cama mediante velcro, fijado únicamente a la parte superior. Pliegues separados de número variable sobre el revestimiento, a fin de resaltar su blandura. Fondo en pliegues no disponible para acabado en piel. Patas no visibles.



Velcrato
Velcro
Velcro
Klettverschluss
Velcro

Andaman
Bahamas
Capri
Ebridi
Elba
Figi Letto
Figi Letto Soggiorno
Flores
Grenada
Linosa
Lipari
Lipari Plus
Nest

Libero
Smooth
Libre
Frei
Libre

Panarea
Panarea Soggiorno
Tahiti
Tahiti Soggiorno
Tasca
Tasca Soggiorno

Fondo piega
Pleated corners
Plissé
Bodenfalte
Fondo en pliegues

Elba Plus
Linosa Plus
Sardegna
Sardegna Soggiorno
White
White High
White Soggiorno

Finitura › rovere moca › rovere bianco	Finish › mocha oak › white oak	Finition › chêne moka › chêne blanc	Ausführung › Eiche Mokka › Eiche Weiß	Acabado › roble moca › roble blanco
Giroletto imbottito con rivestimento sfoderabile › tessuto › pelle › ecopelle	Upholstered bed frame with removable cover › fabric › leather › faux leather	Cadre de lit rembourré avec revêtement amovible › tissu › cuir › similcuir	Gepolsterter Bettrahmen mit abnehmbarem Bezug › Stoff › Leder › Kunstleder	Marco de la cama tapizado con revestimiento amovible › tejido › piel › ecopiel
Di serie › giroletto a filo del materasso › piano ortopedico	Standard › bed frame flush with the mattress › orthopaedic bed base	De série › cadre de lit au ras du matelas › plateau orthopédique	Serienausstattung › Bettrahmen bündig zur Matratze › orthopädische Basis	De serie › marco de la cama a ras del colchón › somier ortopédico
Materasso venduto a parte › consulta il catalogo The Art of Sleeping www.orizzontiitalia.it	Mattress sold separately › see the catalogue The Art of Sleeping www.orizzontiitalia.it	Matelas vendu séparément › voir le catalogue The Art of Sleeping www.orizzontiitalia.it	Matratze separat erhältlich › zum Katalog The Art of Sleeping www.orizzontiitalia.it	Colchón se vende por separado › consultar el catálogo The Art of Sleeping www.orizzontiitalia.it

Letto imbottito con rivestimento sfoderabile › tessuto › pelle › ecopelle	Upholstered bed with removable cover › fabric › leather › faux leather	Lit rembourré avec revêtement amovible › tissu › cuir › similcuir	Gepolsteres Bett mit abnehmbarem Bezug › Stoff › Leder › Kunstleder	Cama tapizada con revestimiento amovible › tejido › piel › ecopiel
Di serie › giroletto esterno al materasso › piedi in legno › rete a doghe	Standard › bed frame outside the mattress › wooden feet › slatted base	De série › cadre de lit à l'extérieur du matelas › pieds en bois › sommier à lattes	Serienausstattung › Bettrahmen außerhalb der Matratze › Holzfüße › Lattenrost	De serie › marco de la cama fuera del colchón › patas de madera › somier de lamas
Optional › vano contenitore con rete alzabile a doppia apertura › doghe ammortizzate › piano ortopedico › rete amagnetica › rete motorizzata › giroletto a filo del materasso	Optionals › storage compartment with double opening lifttable base › sprung slats › orthopaedic bed base › non-magnetic base › electric adjustable base › bed frame flush with the mattress	Options › coffre avec sommier relevable à double ouverture › sommier à lattes amorties › plateau orthopédique › sommier non magnétique › sommier motorisé › cadre de lit au ras du matelas	Optionale Ausstattung › Bettkasten mit zwei verschiedene Liffunktionen › gefederter Lattenrost › orthopädische Basis › Holzrahmen Lattenrost › motorischer Lattenrost › Bettrahmen bündig zur Matratze	Opcionales › arcón con somier elevable de doble abertura › lamas amortiguadas › somier ortopédico › somier no magnético › somier motorizado › marco de la cama a ras del colchón
Materasso venduto a parte › consulta il catalogo The Art of Sleeping www.orizzontiitalia.it	Mattress sold separately › see the catalogue The Art of Sleeping www.orizzontiitalia.it	Matelas vendu séparément › voir le catalogue The Art of Sleeping www.orizzontiitalia.it	Matratze separat erhältlich › zum Katalog The Art of Sleeping www.orizzontiitalia.it	Colchón se vende por separado › consultar el catálogo The Art of Sleeping www.orizzontiitalia.it



Materasso Mattress (cm)	Ingombro Bed size (cm)
160 x 200	174 x 228 x 92H

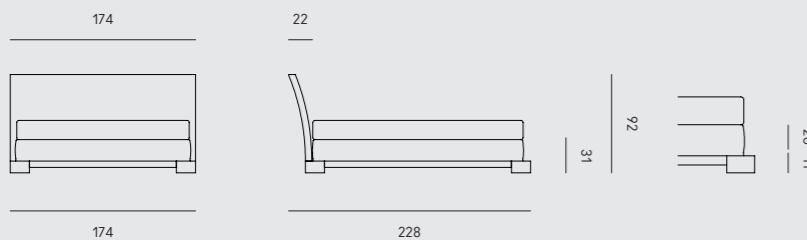

Materasso Mattress (cm)	Ingombro Bed size (cm)
100 x 200	111 x 228 x 98H
160 x 200	171 x 228 x 98H
170 x 200	181 x 228 x 98H
180 x 200	191 x 228 x 98H
200 x 200	211 x 228 x 98H
American Queen Size 60" x 80"	64.2" x 90.9" x 38.6"H
American King Size 76" x 80"	80.3" x 90.9" x 38.6"H

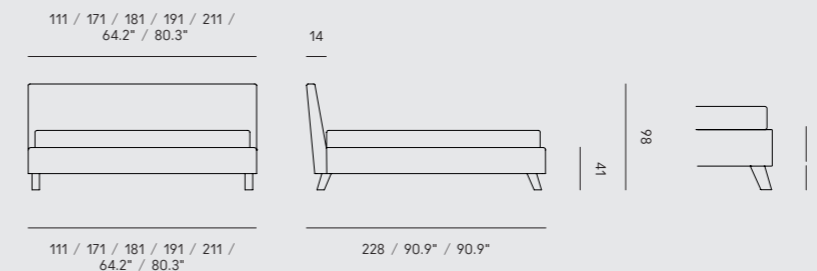

Letto imbottito con rivestimento sfoderabile

- > tessuto
- > pelle
- > ecopelle

Upholstered bed with removable cover

- > fabric
- > leather
- > faux leather

Lit rembourré avec revêtement amovible

- > tissu
- > cuir
- > similcuir

Gepolstertes Bett mit abnehmbarem Bezug

- > Stoff
- > Leder
- > Kunstleder

Cama tapizada con revestimiento amovible

- > tejido
- > piel
- > ecopiel

Di serie

- > giroletto esterno al materasso
- > piedi in legno
- > rete a doghe

Standard

- > bed frame outside the mattress
- > wooden feet
- > slatted base

De série

- > cadre de lit à l'extérieur du matelas
- > pieds en bois
- > sommier à lattes

Serienausstattung

- > Bettrahmen außerhalb der Matratze
- > Holzfüße
- > Lattenrost

De serie

- > marco de la cama fuera del colchón
- > patas de madera
- > somier de lamas

Optional

- > vano contenitore con rete alzabile a doppia apertura
- > doghe ammortizzate
- > piano ortopedico
- > rete amagnetica
- > rete motorizzata
- > giroletto a filo del materasso

Optionals

- > storage compartment with double opening lifttable base
- > sprung slats
- > orthopaedic bed base
- > non-magnetic base
- > electric adjustable base
- > bed frame flush with the mattress

Options

- > coffre avec sommier relevable à double ouverture
- > sommier à lattes amorties
- > plateau orthopédique
- > sommier non magnétique
- > sommier motorisé
- > cadre de lit au ras du matelas

Optionale Ausstattung

- > Bettkasten mit zwei verschiedene Liffunktionen
- > gefederter Lattenrost
- > orthopädische Basis
- > Holzrahmen Lattenrost
- > motorischer Lattenrost
- > Bettrahmen bündig zur Matratze

Opcionales

- > arcón con somier elevable de doble abertura
- > lamas amortiguadas
- > somier ortopédico
- > somier no magnético
- > somier motorizado
- > marco de la cama a ras del colchón

Materasso venduto a parte

- > consulta il catalogo The Art of Sleeping www.orizzontiitalia.it

Mattress sold separately

- > see the catalogue The Art of Sleeping www.orizzontiitalia.it

Matelas vendu séparément

- > voir le catalogue The Art of Sleeping www.orizzontiitalia.it

Matratze separat erhältlich

- > zum Katalog The Art of Sleeping www.orizzontiitalia.it

Colchón

- > se vende por separado
- > consultar el catálogo The Art of Sleeping www.orizzontiitalia.it

Letto imbottito con rivestimento sfoderabile

- > tessuto
- > pelle
- > ecopelle

Upholstered bed with removable cover

- > fabric
- > leather
- > faux leather

Lit rembourré avec revêtement amovible

- > tissu
- > cuir
- > similcuir

Gepolstertes Bett mit abnehmbarem Bezug

- > Stoff
- > Leder
- > Kunstleder

Cama tapizada con revestimiento amovible

- > tejido
- > piel
- > ecopiel

Di serie

- > giroletto esterno al materasso
- > piedi in metallo
- > rete a doghe

Standard

- > bed frame outside the mattress
- > metal feet
- > slatted base

De série

- > cadre de lit à l'extérieur du matelas
- > pieds en métal
- > sommier à lattes

Serienausstattung

- > Bettrahmen außerhalb der Matratze
- > Metallfüße
- > Lattenrost

De serie

- > marco de la cama fuera del colchón
- > patas de metal
- > somier de lamas

Optional

- > vano contenitore con rete alzabile a doppia apertura
- > doghe ammortizzate
- > piano ortopedico
- > rete amagnetica
- > rete motorizzata
- > giroletto a filo del materasso

Optionals

- > storage compartment with double opening lifttable base
- > sprung slats
- > orthopaedic bed base
- > non-magnetic base
- > electric adjustable base
- > bed frame flush with the mattress

Options

- > coffre avec sommier relevable à double ouverture
- > sommier à lattes amorties
- > plateau orthopédique
- > sommier non magnétique
- > sommier motorisé
- > cadre de lit au ras du matelas

Optionale Ausstattung

- > Bettkasten mit zwei verschiedene Liffunktionen
- > gefederter Lattenrost
- > orthopädische Basis
- > Holzrahmen Lattenrost
- > motorischer Lattenrost
- > Bettrahmen bündig zur Matratze

Opcionales

- > arcón con somier elevable de doble abertura
- > lamas amortiguadas
- > somier ortopédico
- > somier no magnético
- > somier motorizado
- > marco de la cama a ras del colchón

Materasso venduto a parte

- > consulta il catalogo The Art of Sleeping www.orizzontiitalia.it

Mattress sold separately

- > see the catalogue The Art of Sleeping www.orizzontiitalia.it

Matelas vendu séparément

- > voir le catalogue The Art of Sleeping www.orizzontiitalia.it

Matratze separat erhältlich

- > zum Katalog The Art of Sleeping www.orizzontiitalia.it

Colchón

- > se vende por separado
- > consultar el catálogo The Art of Sleeping www.orizzontiitalia.it



Materasso Mattress (cm)	Ingombro Bed size (cm)
100 x 200	111 x 228 x 88H
160 x 200	171 x 228 x 88H
170 x 200	181 x 228 x 88H
180 x 200	191 x 228 x 88H
200 x 200	211 x 228 x 88H
American Queen Size 60" x 80"	64.2" x 90.9" x 34.6"H
American King Size 76" x 80"	80.3" x 90.9" x 34.6"H

111 / 171 / 181 / 191 / 211 /
64.2" / 80.3"

14

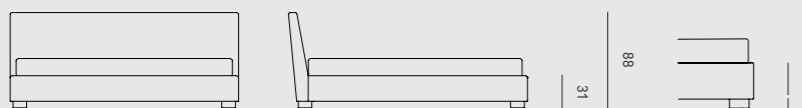
111 / 171 / 181 / 191 / 211 /
64.2" / 80.3"

228 / 90.9" / 90.9"



Materasso Mattress (cm)	Ingombro Bed size (cm)
100 x 200	111 x 228 x 98H
160 x 200	171 x 228 x 98H
170 x 200	181 x 228 x 98H
180 x 200	191 x 228 x 98H
200 x 200	211 x 228 x 98H
American Queen Size 60" x 80"	64.2" x 90.9" x 38.6"H
American King Size 76" x 80"	80.3" x 90.9" x 38.6"H

111 / 171 / 181 / 191 / 211 /
64.2" / 80.3"

14

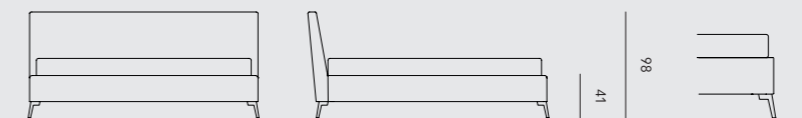
111 / 171 / 181 / 191 / 211 /
64.2" / 80.3"

228 / 90.9" / 90.9"

Letto imbottito con rivestimento sfoderabile

- > tessuto
- > pelle
- > ecopelle

Upholstered bed with removable cover

- > fabric
- > leather
- > faux leather

Lit rembourré avec revêtement amovible

- > tissu
- > cuir
- > similcuir

Gepolstertes Bett mit abnehmbarem Bezug

- > Stoff
- > Leder
- > Kunstleder

Cama tapizada con revestimiento amovible

- > tejido
- > piel
- > ecopiel

Di serie

- > piedi in legno
- > rete a doghe

Standard

- > wooden feet
- > slatted base

De série

- > pieds en bois
- > sommier à lattes

Serienausstattung

- > Holzfüße
- > Lattenrost

De serie

- > patas de madera
- > somier de lamas

Materasso venduto a parte

- > consulta il catalogo
- The Art of Sleeping
- www.orizzontiitalia.it

Mattress sold separately

- > see the catalogue
- The Art of Sleeping
- www.orizzontiitalia.it

Matelas vendu séparément

- > voir le catalogue
- The Art of Sleeping
- www.orizzontiitalia.it

Matratze separat erhältlich

- > zum Katalog
- The Art of Sleeping
- www.orizzontiitalia.it

Colchón se vende por separado

- > consultar el catálogo
- The Art of Sleeping
- www.orizzontiitalia.it

Letto imbottito con rivestimento sfoderabile

- > tessuto
- > pelle
- > ecopelle

Upholstered bed with removable cover

- > fabric
- > leather
- > faux leather

Lit rembourré avec revêtement amovible

- > tissu
- > cuir
- > similcuir

Gepolstertes Bett mit abnehmbarem Bezug

- > Stoff
- > Leder
- > Kunstleder

Cama tapizada con revestimiento amovible

- > tejido
- > piel
- > ecopiel

Di serie

- > piedi in metallo
- > rete a doghe

Standard

- > metal feet
- > slatted base

De série

- > pieds en métal
- > sommier à lattes

Serienausstattung

- > Metallfüße
- > Lattenrost

De serie

- > patas de metal
- > somier de lamas

Materasso venduto a parte

- > consulta il catalogo
- The Art of Sleeping
- www.orizzontiitalia.it

Mattress sold separately

- > see the catalogue
- The Art of Sleeping
- www.orizzontiitalia.it

Matelas vendu séparément

- > voir le catalogue
- The Art of Sleeping
- www.orizzontiitalia.it

Matratze separat erhältlich

- > zum Katalog
- The Art of Sleeping
- www.orizzontiitalia.it

Colchón se vende por separado

- > consultar el catálogo
- The Art of Sleeping
- www.orizzontiitalia.it



Materasso Mattress (cm)	Ingombro Bed size (cm)
160 x 200	180 x 228 x 91H
170 x 200	190 x 228 x 91H
180 x 200	200 x 228 x 91H
American Queen Size 60" x 80"	67.7" x 90.9" x 35.8"H
American King Size 76" x 80"	83.9" x 90.9" x 35.8"H

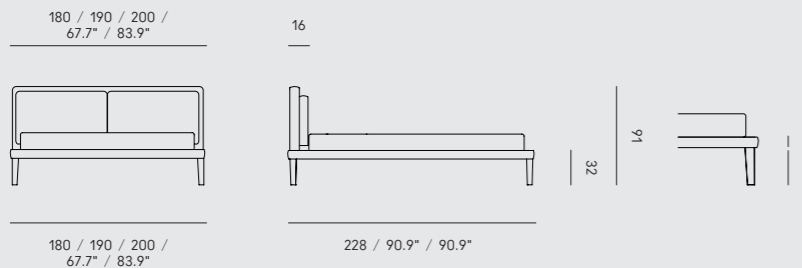

Materasso Mattress (cm)	Ingombro Bed size (cm)
160 x 200	180 x 228 x 91H
170 x 200	190 x 228 x 91H
180 x 200	200 x 228 x 91H
American Queen Size 60" x 80"	67.7" x 90.9" x 35.8"H
American King Size 76" x 80"	83.9" x 90.9" x 35.8"H

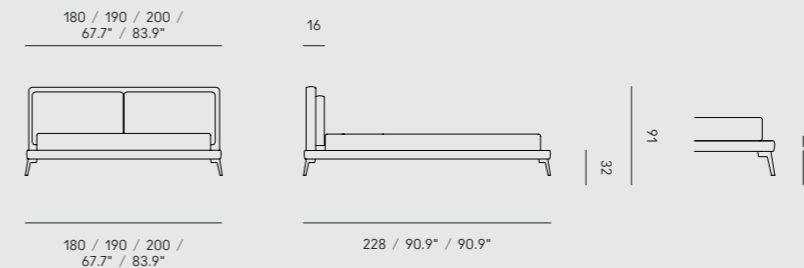

Letto imbottito con rivestimento sfoderabile

- > tessuto
- > pelle
- > ecopelle

Upholstered bed with removable cover

- > fabric
- > leather
- > faux leather

Lit rembourré avec revêtement amovible

- > tissu
- > cuir
- > similcuir

Gepolstertes Bett mit abnehmbarem Bezug

- > Stoff
- > Leder
- > Kunstleder

Cama tapizada con revestimiento amovible

- > tejido
- > piel
- > ecopiel

Varianti

- > testiera tessile
- > testiera trapuntata

Variants

- > plain headboard
- > quilted headboard

Variantes

- > tête de lit lisse
- > tête de lit matelassé

Varianten

- > glatter Kopfteil
- > gesteppter Kopfteil

Variantes

- > cabecero liso
- > cabecero acolchado

Di serie

- > piedi in legno
- > rete a doghe

Standard

- > wooden feet
- > slatted base

De série

- > pieds en bois
- > sommier à lattes

Serienausstattung

- > Holzfüße
- > Lattenrost

De serie

- > patas de madera
- > somier de lamas

Materasso venduto a parte

- > consulta il catalogo
- The Art of Sleeping
- www.orizzontiitalia.it

Mattress sold separately

- > see the catalogue
- The Art of Sleeping
- www.orizzontiitalia.it

Matelas vendu séparément

- > voir le catalogue
- The Art of Sleeping
- www.orizzontiitalia.it

Matratze separat erhältlich

- > zum Katalog
- The Art of Sleeping
- www.orizzontiitalia.it

Colchón

- se vende por separado
- > consultar el catálogo
- The Art of Sleeping
- www.orizzontiitalia.it

Letto imbottito con rivestimento sfoderabile

- > tessuto
- > pelle
- > ecopelle

Upholstered bed with removable cover

- > fabric
- > leather
- > faux leather

Lit rembourré avec revêtement amovible

- > tissu
- > cuir
- > similcuir

Gepolstertes Bett mit abnehmbarem Bezug

- > Stoff
- > Leder
- > Kunstleder

Cama tapizada con revestimiento amovible

- > tejido
- > piel
- > ecopiel

Varianti

- > testiera tessile
- > testiera trapuntata

Variants

- > plain headboard
- > quilted headboard

Variantes

- > tête de lit lisse
- > tête de lit matelassé

Varianten

- > glatter Kopfteil
- > gesteppter Kopfteil

Variantes

- > cabecero liso
- > cabecero acolchado

Di serie

- > piedi in legno
- > rete a doghe

Standard

- > metal feet
- > slatted base

De série

- > pieds en métal
- > sommier à lattes

Serienausstattung

- > Metallfüße
- > Lattenrost

De serie

- > patas de metal
- > somier de lamas

Materasso venduto a parte

- > consulta il catalogo
- The Art of Sleeping
- www.orizzontiitalia.it

Mattress sold separately

- > see the catalogue
- The Art of Sleeping
- www.orizzontiitalia.it

Matelas vendu séparément

- > voir le catalogue
- The Art of Sleeping
- www.orizzontiitalia.it

Matratze separat erhältlich

- > zum Katalog
- The Art of Sleeping
- www.orizzontiitalia.it

Colchón

- se vende por separado
- > consultar el catálogo
- The Art of Sleeping
- www.orizzontiitalia.it



Materasso Mattress (cm)	Ingombro Bed size (cm)
100 x 200	110 x 216 x 92H
160 x 200	170 x 216 x 92H
170 x 200	180 x 216 x 92H
180 x 200	190 x 216 x 92H
American Queen Size 60" x 80"	63.8" x 86.2" x 36.2"H
American King Size 76" x 80"	79.9" x 86.2" x 36.2"H

110 / 170 / 180 / 190 /
63.8" / 79.9"

10

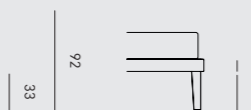
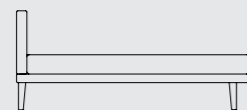
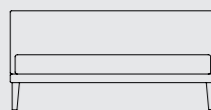
180 / 190 / 200 /
63.8" / 79.9"

216 / 86.2" / 86.2"



Materasso Mattress (cm)	Ingombro Bed size (cm)
100 x 200	110 x 216 x 92H
160 x 200	170 x 216 x 92H
170 x 200	180 x 216 x 92H
180 x 200	190 x 216 x 92H
American Queen Size 60" x 80"	63.8" x 86.2" x 36.2"H
American King Size 76" x 80"	79.9" x 86.2" x 36.2"H

110 / 170 / 180 / 190 /
63.8" / 79.9"

10

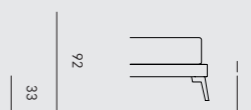
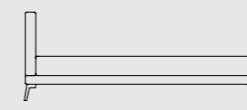
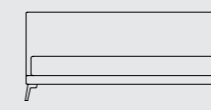
180 / 190 / 200 /
63.8" / 79.9"

216 / 86.2" / 86.2"

Letto imbottito con rivestimento sfoderabile

- > tessuto
- > pelle
- > ecopelle

Upholstered bed with removable cover

- > fabric
- > leather
- > faux leather

Lit rembourré avec revêtement amovible

- > tissu
- > cuir
- > similcuir

Gepolstertes Bett mit abnehmbarem Bezug

- > Stoff
- > Leder
- > Kunstleder

Cama tapizada con revestimiento amovible

- > tejido
- > piel
- > ecopiel

Di serie

- > piedi in legno
- > rete a doghe

Standard

- > wooden feet
- > slatted base

De série

- > pieds en bois
- > sommier à lattes

Serienausstattung

- > Holzfüße
- > Lattenrost

De serie

- > patas de madera
- > somier de lamas

Materasso venduto a parte

- > consulta il catalogo
- The Art of Sleeping
- www.orizzontiitalia.it

Mattress sold separately

- > see the catalogue
- The Art of Sleeping
- www.orizzontiitalia.it

Matelas vendu séparément

- > voir le catalogue
- The Art of Sleeping
- www.orizzontiitalia.it

Matratze separat erhältlich

- > zum Katalog
- The Art of Sleeping
- www.orizzontiitalia.it

Colchón se vende por separado

- > consultar el catálogo
- The Art of Sleeping
- www.orizzontiitalia.it

Letto imbottito con rivestimento sfoderabile

- > tessuto
- > pelle
- > ecopelle

Upholstered bed with removable cover

- > fabric
- > leather
- > faux leather

Lit rembourré avec revêtement amovible

- > tissu
- > cuir
- > similcuir

Gepolstertes Bett mit abnehmbarem Bezug

- > Stoff
- > Leder
- > Kunstleder

Cama tapizada con revestimiento amovible

- > tejido
- > piel
- > ecopiel

Di serie

- > piedi in metallo
- > rete a doghe

Standard

- > metal feet
- > slatted base

De série

- > pieds en métal
- > sommier à lattes

Serienausstattung

- > Metallfüße
- > Lattenrost

De serie

- > patas de metal
- > somier de lamas

Materasso venduto a parte

- > consulta il catalogo
- The Art of Sleeping
- www.orizzontiitalia.it

Mattress sold separately

- > see the catalogue
- The Art of Sleeping
- www.orizzontiitalia.it

Matelas vendu séparément

- > voir le catalogue
- The Art of Sleeping
- www.orizzontiitalia.it

Matratze separat erhältlich

- > zum Katalog
- The Art of Sleeping
- www.orizzontiitalia.it

Colchón se vende por separado

- > consultar el catálogo
- The Art of Sleeping
- www.orizzontiitalia.it



Materasso Mattress (cm)	Ingombro Bed size (cm)
100 x 200	110 x 210 x 33H
160 x 200	170 x 210 x 33H
170 x 200	180 x 210 x 33H
180 x 200	190 x 210 x 33H
American Queen Size 60" x 80"	63.8" x 83.9" x 13.0"H
American King Size 76" x 80"	79.9" x 83.9" x 13.0"H



Materasso Mattress (cm)	Ingombro Bed size (cm)
100 x 200	110 x 210 x 33H
160 x 200	170 x 210 x 33H
170 x 200	180 x 210 x 33H
180 x 200	190 x 210 x 33H
American Queen Size 60" x 80"	63.8" x 83.9" x 13.0"H
American King Size 76" x 80"	79.9" x 83.9" x 13.0"H

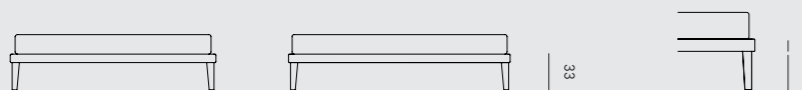

110 / 170 / 180 / 190 /
63.8" / 79.9"

210 / 83.9" / 83.9"

33

8 25

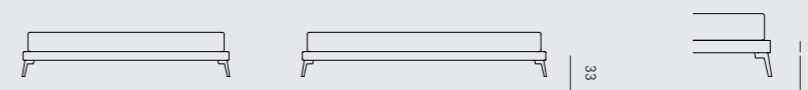

110 / 170 / 180 / 190 /
63.8" / 79.9"

210 / 83.9" / 83.9"

33

8 25

Letto imbottito con rivestimento sfoderabile

- › tessuto
- › pelle
- › ecopelle

Di serie

- › giroletto esterno al materasso
- › piedi in legno
- › rete a doghe

Optional

- › vano contenitore con rete alzabile a doppia apertura
- › doghe ammortizzate
- › piano ortopedico
- › rete amagnetica
- › rete motorizzata
- › giroletto a filo del materasso

Materasso venduto a parte

- › consulta il catalogo The Art of Sleeping www.orizzontiitalia.it

Upholstered bed with removable cover

- › fabric
- › leather
- › faux leather

Standard

- › bed frame outside the mattress
- › wooden feet
- › slatted base

Optionals

- › storage compartment with double opening liftable base
- › sprung slats
- › orthopaedic bed base
- › non-magnetic base
- › electric adjustable base
- › bed frame flush with the mattress

Mattress sold separately

- › see the catalogue The Art of Sleeping www.orizzontiitalia.it

Lit rembourré avec revêtement amovible

- › tissu
- › cuir
- › similcuir

De série

- › cadre de lit à l'extérieur du matelas
- › pieds en bois
- › sommier à lattes

Options

- › coffre avec sommier relevable à double ouverture
- › sommier à lattes amorties
- › plateau orthopédique
- › sommier non magnétique
- › sommier motorisé
- › cadre de lit au ras du matelas

Matelas vendu séparément

- › voir le catalogue The Art of Sleeping www.orizzontiitalia.it

Gepolstertes Bett mit abnehmbarem Bezug

- › Stoff
- › Leder
- › Kunstleder

Serienausstattung

- › Bettrahmen außerhalb der Matratze
- › Holzfüße
- › Lattenrost

Optionale Ausstattung

- › Bettkasten mit zwei verschiedene Liffunktionen
- › gefederter Lattenrost
- › orthopädische Basis
- › Holzrahmen Lattenrost
- › motorischer Lattenrost
- › Bettrahmen bündig zur Matratze

Matratze separat erhältlich

- › zum Katalog The Art of Sleeping www.orizzontiitalia.it

Cama tapizada con revestimiento amovible

- › tejido
- › piel
- › ecopiel

De serie

- › marco de la cama fuera del colchón
- › patas de madera
- › somier de lamas

Opcionales

- › arcón con somier elevable de doble abertura
- › lamas amortiguadas
- › somier ortopédico
- › somier no magnético
- › somier motorizado
- › marco de la cama a ras del colchón

Colchón

- › se vende por separado
- › consultar el catálogo The Art of Sleeping www.orizzontiitalia.it

Letto imbottito con rivestimento sfoderabile

- › tessuto
- › ecopelle

Di serie

- › giroletto esterno al materasso
- › piedi in legno
- › rete a doghe

Optional

- › vano contenitore con rete alzabile a doppia apertura
- › doghe ammortizzate
- › piano ortopedico
- › rete amagnetica
- › rete motorizzata
- › giroletto a filo del materasso

Materasso venduto a parte

- › consulta il catalogo The Art of Sleeping www.orizzontiitalia.it

Upholstered bed with removable cover

- › fabric
- › faux leather

Standard

- › bed frame outside the mattress
- › wooden feet
- › slatted base

Optionals

- › storage compartment with double opening liftable base
- › sprung slats
- › orthopaedic bed base
- › non-magnetic base
- › electric adjustable base
- › bed frame flush with the mattress

Mattress sold separately

- › see the catalogue The Art of Sleeping www.orizzontiitalia.it

Lit rembourré avec revêtement amovible

- › tissu
- › similcuir

De série

- › cadre de lit à l'extérieur du matelas
- › pieds en bois
- › sommier à lattes

Options

- › coffre avec sommier relevable à double ouverture
- › sommier à lattes amorties
- › plateau orthopédique
- › sommier non magnétique
- › sommier motorisé
- › cadre de lit au ras du matelas

Matelas vendu séparément

- › voir le catalogue The Art of Sleeping www.orizzontiitalia.it

Gepolstertes Bett mit abnehmbarem Bezug

- › Stoff
- › Kunstleder

Serienausstattung

- › Bettrahmen außerhalb der Matratze
- › Holzfüße
- › Lattenrost

Optionale Ausstattung

- › Bettkasten mit zwei verschiedene Liffunktionen
- › gefederter Lattenrost
- › orthopädische Basis
- › Holzrahmen Lattenrost
- › motorischer Lattenrost
- › Bettrahmen bündig zur Matratze

Matratze separat erhältlich

- › zum Katalog The Art of Sleeping www.orizzontiitalia.it

Cama tapizada con revestimiento amovible

- › tejido
- › ecopiel

De serie

- › marco de la cama fuera del colchón
- › patas de madera
- › somier de lamas

Opcionales

- › arcón con somier elevable de doble abertura
- › lamas amortiguadas
- › somier ortopédico
- › somier no magnético
- › somier motorizado
- › marco de la cama a ras del colchón

Colchón

- › se vende por separado
- › consultar el catálogo The Art of Sleeping www.orizzontiitalia.it



Materasso Mattress (cm)	Ingombro Bed size (cm)
90 x 200	112 x 217 x 94H
100 x 200	122 x 217 x 94H
120 x 200	142 x 217 x 94H
140 x 200	162 x 217 x 94H
160 x 200	182 x 217 x 94H
170 x 200	192 x 217 x 94H
180 x 200	202 x 217 x 94H
200 x 200	222 x 217 x 94H
American Queen Size 60" x 80"	68.5" x 86.6" x 37.0"H
American King Size 76" x 80"	84.6" x 86.6" x 37.0"H

112 / 122 / 142 / 162 / 182 / 192 / 202 / 222 / 68.5" / 84.6"

10

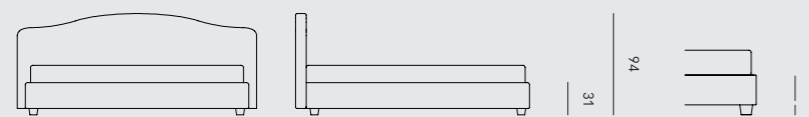

101 / 111 / 131 / 151 / 171 / 181 / 191 / 211 / 64.2" / 80.3"

217 / 86.6" / 86.6"



Materasso Mattress (cm)	Ingombro Bed size (cm)
90 x 200	112 x 217 x 110H
100 x 200	122 x 217 x 110H
120 x 200	142 x 217 x 110H
140 x 200	162 x 217 x 110H
160 x 200	182 x 217 x 110H
170 x 200	192 x 217 x 110H
180 x 200	202 x 217 x 110H
200 x 200	222 x 217 x 110H
American Queen Size 60" x 80"	68.5" x 86.6" x 43.3"H
American King Size 76" x 80"	84.6" x 86.6" x 43.3"H

112 / 122 / 142 / 162 / 182 / 192 / 202 / 222 / 68.5" / 84.6"

10

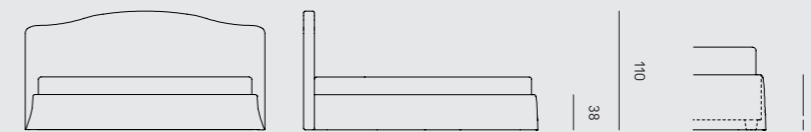

101 / 111 / 131 / 151 / 171 / 181 / 191 / 211 / 64.2" / 80.3"

217 / 86.6" / 86.6"

Letto imbottito con rivestimento sfoderabile

- > tessuto
- > pelle
- > ecopelle

Upholstered bed with removable cover

- > fabric
- > leather
- > faux leather

Lit rembourré avec revêtement amovible

- > tissu
- > cuir
- > similcuir

Gepolstertes Bett mit abnehmbarem Bezug

- > Stoff
- > Leder
- > Kunstleder

Cama tapizada con revestimiento amovible

- > tejido
- > piel
- > ecopiel

Di serie

- > giroletto esterno al materasso
- > piedi in legno
- > rete a doghe

Standard

- > bed frame outside the mattress
- > wooden feet
- > slatted base

De série

- > cadre de lit à l'extérieur du matelas
- > pieds en bois
- > sommier à lattes

Serienausstattung

- > Bettrahmen außerhalb der Matratze
- > Holzfüße
- > Lattenrost

De serie

- > marco de la cama fuera del colchón
- > patas de madera
- > somier de lamas

Optional

- > vano contenitore con rete alzabile a doppia apertura
- > doghe ammortizzate
- > piano ortopedico
- > rete amagnetica
- > rete motorizzata
- > giroletto a filo del materasso

Optionals

- > storage compartment with double opening
- > sprung slats
- > orthopaedic bed base
- > non-magnetic base
- > electric adjustable base
- > bed frame flush with the mattress

Options

- > coffre avec sommier relevable à double ouverture
- > sommier à lattes amorties
- > plateau orthopédique
- > sommier non magnétique
- > sommier motorisé
- > cadre de lit au ras du matelas

Optionale Ausstattung

- > Bettkasten mit zwei verschiedene Liffunktionen
- > gefederter Lattenrost
- > orthopädische Basis
- > Holzrahmen Lattenrost
- > motorischer Lattenrost
- > Bettrahmen bündig zur Matratze

Opcionales

- > arcón con somier elevable de doble abertura
- > lamas amortiguadas
- > somier ortopédico
- > somier no magnético
- > somier motorizado
- > marco de la cama a ras del colchón

Materasso venduto a parte

- > consulta il catalogo The Art of Sleeping www.orizzontiitalia.it

Mattress sold separately

- > see the catalogue The Art of Sleeping www.orizzontiitalia.it

Matelas vendu séparément

- > voir le catalogue The Art of Sleeping www.orizzontiitalia.it

Matratze separat erhältlich

- > zum Katalog The Art of Sleeping www.orizzontiitalia.it

Colchón

- > se vende por separado
- > consultar el catálogo The Art of Sleeping www.orizzontiitalia.it

Letto imbottito con rivestimento sfoderabile

- > tessuto
- > pelle
- > ecopelle

Upholstered bed with removable cover

- > fabric
- > leather
- > faux leather

Lit rembourré avec revêtement amovible

- > tissu
- > cuir
- > similcuir

Gepolstertes Bett mit abnehmbarem Bezug

- > Stoff
- > Leder
- > Kunstleder

Cama tapizada con revestimiento amovible

- > tejido
- > piel
- > ecopiel

Di serie

- > giroletto esterno al materasso
- > piedi in legno
- > rete superiore a doghe
- > rete estraibile in legno

Standard

- > bed frame outside the mattress
- > wooden feet
- > upper slatted base
- > wooden pull-out base

De série

- > cadre de lit à l'extérieur du matelas
- > pieds en bois
- > sommier à lattes
- > sommier extractible en bois

Serienausstattung

- > Bettrahmen außerhalb der Matratze
- > Holzfüße
- > oberer Lattenrost
- > ausziehbarer Holzlattenrost

De serie

- > marco de la cama fuera del colchón
- > patas de madera
- > somier de lamas
- > sommier extraible en madera

Materasso venduto a parte

- > materasso superiore: consulta il catalogo The Art of Sleeping www.orizzontiitalia.it
- > materasso inferiore: Sit & Sleep Standard Sit & Sleep Memory

Mattress sold separately

- > upper mattress: see the catalogue The Art of Sleeping www.orizzontiitalia.it
- > lower mattress: Sit & Sleep Standard Sit & Sleep Memory

Matelas vendu séparément

- > matelas supérieur: voir le catalogue The Art of Sleeping www.orizzontiitalia.it
- > matelas inférieur: Sit & Sleep Standard Sit & Sleep Memory

Matratze separat erhältlich

- > Obermatratze: zum Katalog The Art of Sleeping www.orizzontiitalia.it
- > Untermatratze: Sit & Sleep Standard Sit & Sleep Memory

Colchón se vende por separado

- > colchón superior: consultar el catálogo The Art of Sleeping www.orizzontiitalia.it
- > colchón inferior: Sit & Sleep Standard Sit & Sleep Memory



Materasso Mattress (cm)	Ingombro Bed size (cm)
80 x 200	93 x 216 x 77H
90 x 200	103 x 216 x 77H
100 x 200	113 x 216 x 77H
120 x 200	133 x 216 x 77H
140 x 200	153 x 216 x 77H
160 x 200	173 x 216 x 77H
170 x 200	183 x 216 x 77H
180 x 200	193 x 216 x 77H
200 x 200	213 x 216 x 77H
American Queen Size 60" x 80"	65.0" x 86.2" x 30.3"H
American King Size 76" x 80"	81.1" x 86.2" x 30.3"H



Materasso superiore Top mattress (cm)	Materasso inferiore Pull-out bed mattress (cm)	Ingombro Bed size (cm)
80 x 200	75 x 190 x 12H	93 x 219 x 77H
90 x 200	85 x 190 x 12H	103 x 219 x 77H
100 x 200	85 x 190 x 12H	113 x 219 x 77H

93 / 103 / 113 / 133 / 153 / 173 / 183 / 193 / 213 / 65.0" / 81.1"

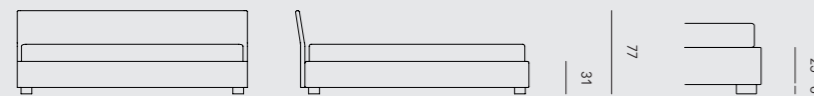

91 / 101 / 111 / 131 / 151 / 171 / 181 / 191 / 211 / 64.2" / 80.3"

216 / 86.2" / 86.2"

93 / 103 / 113

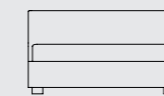

91 / 101 / 111

9

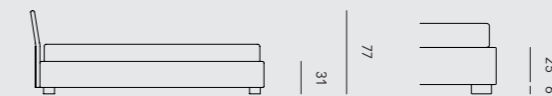

219

Letto imbottito con rivestimento sfoderabile

- › tessuto
- › pelle
- › ecopelle

Upholstered bed with removable cover

- › fabric
- › leather
- › faux leather

Lit rembourré avec revêtement amovible

- › tissu
- › cuir
- › similcuir

Gepolstertes Bett mit abnehmbarem Bezug

- › Stoff
- › Leder
- › Kunstleder

Cama tapizada con revestimiento amovible

- › tejido
- › piel
- › ecopiel

Di serie

- › giroletto esterno al materasso
- › piedi in legno
- › rete a doghe

Standard

- › bed frame outside the mattress
- › wooden feet
- › slatted base

De série

- › cadre de lit à l'extérieur du matelas
- › pieds en bois
- › sommier à lattes

Serienausstattung

- › Bettrahmen außerhalb der Matratze
- › Holzfüße
- › Lattenrost

De serie

- › marco de la cama fuera del colchón
- › patas de madera
- › somier de lamas

Optional

- › vano contenitore con rete alzabile a doppia apertura
- › doghe ammortizzate
- › piano ortopedico
- › rete amagnetica
- › rete motorizzata
- › giroletto a filo del materasso

Optionals

- › storage compartment with double opening
- › lifttable base
- › sprung slats
- › orthopaedic bed base
- › non-magnetic base
- › electric adjustable base
- › bed frame flush with the mattress

Options

- › coffre avec sommier relevable à double ouverture
- › sommier à lattes amorties
- › plateau orthopédique
- › sommier non magnétique
- › sommier motorisé
- › cadre de lit au ras du matelas

Optionale Ausstattung

- › Bettkasten mit zwei verschiedene Liffunktionen
- › gefederter Lattenrost
- › orthopädische Basis
- › Holzrahmen Lattenrost
- › motorischer Lattenrost
- › Bettrahmen bündig zur Matratze

Opcionales

- › arcón con somier elevable de doble abertura
- › lamas amortiguadas
- › somier ortopédico
- › somier no magnético
- › somier motorizado
- › marco de la cama a ras del colchón

Materasso venduto a parte

- › consulta il catalogo The Art of Sleeping www.orizzontiitalia.it

Mattress sold separately

- › see the catalogue The Art of Sleeping www.orizzontiitalia.it

Matelas vendu séparément

- › voir le catalogue The Art of Sleeping www.orizzontiitalia.it

Matratze separat erhältlich

- › zum Katalog The Art of Sleeping www.orizzontiitalia.it

Colchón

- › se vende por separado
- › consultar el catálogo The Art of Sleeping www.orizzontiitalia.it



Materasso Mattress (cm)	Ingombro Bed size (cm)
80 x 200	91 x 211 x 31H
90 x 200	101 x 211 x 31H
100 x 200	111 x 211 x 31H
120 x 200	131 x 211 x 31H
140 x 200	151 x 211 x 31H
160 x 200	171 x 211 x 31H
170 x 200	181 x 211 x 31H
180 x 200	191 x 211 x 31H
200 x 200	211 x 211 x 31H
American Queen Size 60" x 80"	64.2" x 84.3" x 12.2"H
American King Size 76" x 80"	80.3" x 84.3" x 12.2"H

Letto imbottito con rivestimento sfoderabile

- › tessuto
- › pelle
- › ecopelle

Upholstered bed with removable cover

- › fabric
- › leather
- › faux leather

Lit rembourré avec revêtement amovible

- › tissu
- › cuir
- › similcuir

Gepolstertes Bett mit abnehmbarem Bezug

- › Stoff
- › Leder
- › Kunstleder

Cama tapizada con revestimiento amovible

- › tejido
- › piel
- › ecopiel

Di serie

- › giroletto esterno al materasso
- › piedi in legno
- › rete a doghe

Standard

- › bed frame outside the mattress
- › wooden feet
- › slatted base

De série

- › cadre de lit à l'extérieur du matelas
- › pieds en bois
- › sommier à lattes

Serienausstattung

- › Bettrahmen außerhalb der Matratze
- › Holzfüße
- › Lattenrost

De serie

- › marco de la cama fuera del colchón
- › patas de madera
- › somier de lamas

Optional

- › vano contenitore con rete alzabile a doppia apertura
- › doghe ammortizzate
- › piano ortopedico
- › rete amagnetica
- › rete motorizzata

Optionals

- › storage compartment with double opening
- › lifttable base
- › sprung slats
- › orthopaedic bed base
- › non-magnetic base
- › electric adjustable base

Options

- › coffre avec sommier relevable à double ouverture
- › sommier à lattes amorties
- › plateau orthopédique
- › sommier non magnétique
- › sommier motorisé

Optionale Ausstattung

- › Bettkasten mit zwei verschiedene Liffunktionen
- › gefederter Lattenrost
- › orthopädische Basis
- › Holzrahmen Lattenrost
- › motorischer Lattenrost

Opcionales

- › arcón con somier elevable de doble abertura
- › lamas amortiguadas
- › somier ortopédico
- › somier no magnético
- › somier motorizado

Materasso venduto a parte

- › consulta il catalogo The Art of Sleeping www.orizzontiitalia.it

Mattress sold separately

- › see the catalogue The Art of Sleeping www.orizzontiitalia.it

Matelas vendu séparément

- › voir le catalogue The Art of Sleeping www.orizzontiitalia.it

Matratze separat erhältlich

- › zum Katalog The Art of Sleeping www.orizzontiitalia.it

Colchón

- › se vende por separado
- › consultar el catálogo The Art of Sleeping www.orizzontiitalia.it



Materasso Mattress (cm)	Ingombro Bed size (cm)
160 x 200	195 x 221 x 121H
170 x 200	205 x 221 x 121H
180 x 200	215 x 221 x 121H
American Queen Size 60" x 80"	73.6" x 88.2" x 47.6"H
American King Size 76" x 80"	89.8" x 88.2" x 47.6"H

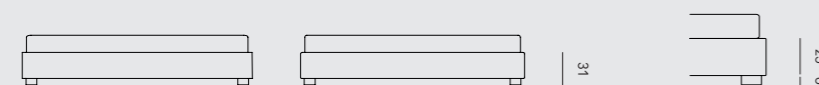
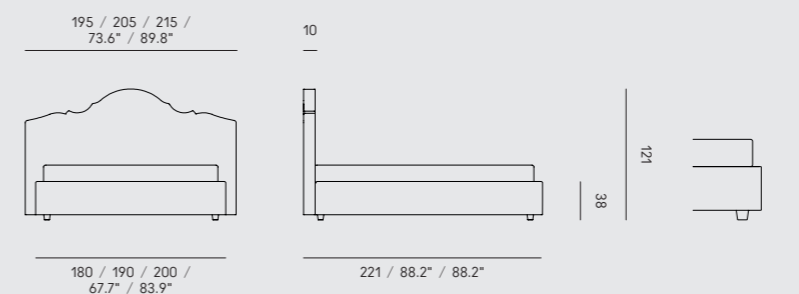

91 / 101 / 111 / 131 / 151 / 171 /
181 / 191 / 211 / 64.2" / 80.3"

211 / 84.3" / 84.3"

Letto imbottito con rivestimento sfoderabile

- › tessuto
- › pelle
- › ecopelle

Upholstered bed with removable cover

- › fabric
- › leather
- › faux leather

Lit rembourré avec revêtement amovible

- › tissu
- › cuir
- › similcuir

Gepolstertes Bett mit abnehmbarem Bezug

- › Stoff
- › Leder
- › Kunstleder

Cama tapizada con revestimiento amovible

- › tejido
- › piel
- › ecopiel

Di serie

- › giroletto esterno al materasso
- › piedi in legno
- › rete a doghe

Standard

- › bed frame outside the mattress
- › wooden feet
- › slatted base

De série

- › cadre de lit à l'extérieur du matelas
- › pieds en bois
- › sommier à lattes

Serienausstattung

- › Bettrahmen außerhalb der Matratze
- › Holzfüße
- › Lattenrost

De serie

- › marco de la cama fuera del colchón
- › patas de madera
- › somier de lamas

Optional

- › vano contenitore con rete alzabile a doppia apertura
- › doghe ammortizzate
- › piano ortopedico
- › rete amagnetica
- › rete motorizzata

Optionals

- › storage compartment with double opening
- › lifttable base
- › sprung slats
- › orthopaedic bed base
- › non-magnetic base
- › electric adjustable base

Options

- › coffre avec sommier relevable à double ouverture
- › sommier à lattes amorties
- › plateau orthopédique
- › sommier non magnétique
- › sommier motorisé

Optionale Ausstattung

- › Bettkasten mit zwei verschiedene Liffunktionen
- › gefederter Lattenrost
- › orthopädische Basis
- › Holzrahmen Lattenrost
- › motorischer Lattenrost

Opcionales

- › arcón con somier elevable de doble abertura
- › lamas amortiguadas
- › somier ortopédico
- › somier no magnético
- › somier motorizado

Materasso venduto a parte

- › consulta il catalogo The Art of Sleeping
- › www.orizzontiitalia.it

Mattress sold separately

- › see the catalogue The Art of Sleeping
- › www.orizzontiitalia.it

Matelas vendu séparément

- › voir le catalogue The Art of Sleeping
- › www.orizzontiitalia.it

Matratze separat erhältlich

- › zum Katalog The Art of Sleeping
- › www.orizzontiitalia.it

Colchón

- › se vende por separado
- › consultar el catálogo The Art of Sleeping
- › www.orizzontiitalia.it

Letto imbottito con rivestimento sfoderabile

- › tessuto
- › pelle
- › ecopelle

Upholstered bed with removable cover

- › fabric
- › leather
- › faux leather

Lit rembourré avec revêtement amovible

- › tissu
- › cuir
- › similcuir

Gepolstertes Bett mit abnehmbarem Bezug

- › Stoff
- › Leder
- › Kunstleder

Cama tapizada con revestimiento amovible

- › tejido
- › piel
- › ecopiel

Di serie

- › giroletto esterno al materasso
- › piedi in legno
- › rete a doghe

Standard

- › bed frame outside the mattress
- › wooden feet
- › slatted base

De série

- › cadre de lit à l'extérieur du matelas
- › pieds en bois
- › sommier à lattes

Serienausstattung

- › Bettrahmen außerhalb der Matratze
- › Holzfüße
- › Lattenrost

De serie

- › marco de la cama fuera del colchón
- › patas de madera
- › somier de lamas

Optional

- › vano contenitore con rete alzabile a doppia apertura
- › doghe ammortizzate
- › piano ortopedico
- › rete amagnetica
- › rete motorizzata

Optionals

- › storage compartment with double opening
- › lifttable base
- › sprung slats
- › orthopaedic bed base
- › non-magnetic base
- › electric adjustable base

Options

- › coffre avec sommier relevable à double ouverture
- › sommier à lattes amorties
- › plateau orthopédique
- › sommier non magnétique
- › sommier motorisé

Optionale Ausstattung

- › Bettkasten mit zwei verschiedene Liffunktionen
- › gefederter Lattenrost
- › orthopädische Basis
- › Holzrahmen Lattenrost
- › motorischer Lattenrost

Opcionales

- › arcón con somier elevable de doble abertura
- › lamas amortiguadas
- › somier ortopédico
- › somier no magnético
- › somier motorizado

Materasso venduto a parte

- › consulta il catalogo The Art of Sleeping
- › www.orizzontiitalia.it

Mattress sold separately

- › see the catalogue The Art of Sleeping
- › www.orizzontiitalia.it

Matelas vendu séparément

- › voir le catalogue The Art of Sleeping
- › www.orizzontiitalia.it

Matratze separat erhältlich

- › zum Katalog The Art of Sleeping
- › www.orizzontiitalia.it

Colchón

- › se vende por separado
- › consultar el catálogo The Art of Sleeping
- › www.orizzontiitalia.it



Materasso Mattress (cm)	Ingombro Bed size (cm)
140 x 200	159 x 221 x 102H
160 x 200	179 x 221 x 102H
170 x 200	189 x 221 x 102H
180 x 200	199 x 221 x 102H
200 x 200	219 x 221 x 102H
American Queen Size 60" x 80"	67.3" x 88.2" x 40.2"H
American King Size 76" x 80"	83.5" x 88.2" x 40.2"H

159 / 179 / 189 / 199 / 219 /
67.3" / 83.5"

10

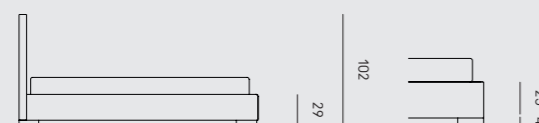
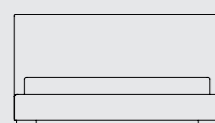
159 / 179 / 189 / 199 / 219 /
67.3" / 83.5"

221 / 88.2" / 88.2"



Materasso Mattress (cm)	Ingombro Bed size (cm)
140 x 200	159 x 221 x 132H
160 x 200	179 x 221 x 132H
170 x 200	189 x 221 x 132H
180 x 200	199 x 221 x 132H
200 x 200	219 x 221 x 132H
American Queen Size 60" x 80"	67.3" x 88.2" x 52.0"H
American King Size 76" x 80"	83.5" x 88.2" x 52.0"H

159 / 179 / 189 / 199 / 219 /
67.3" / 83.5"

10

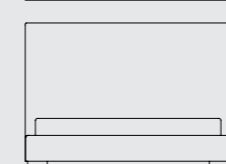
159 / 179 / 189 / 199 / 219 /
67.3" / 83.5"

221 / 88.2" / 88.2"

Letto imbottito con rivestimento sfoderabile

- › tessuto
- › pelle
- › ecopelle

Di serie

- › giroletto esterno al materasso
- › piedi in legno
- › rete a doghe

Optional

- › vano contenitore con rete alzabile a doppia apertura
- › doghe ammortizzate
- › piano ortopedico
- › rete amagnetica
- › rete motorizzata
- › giroletto a filo del materasso

Materasso venduto a parte

- › consulta il catalogo The Art of Sleeping www.orizzontiitalia.it

Upholstered bed with removable cover

- › fabric
- › leather
- › faux leather

Standard

- › bed frame outside the mattress
- › wooden feet
- › slatted base

Optionals

- › storage compartment with double opening lifttable base
- › sprung slats
- › orthopaedic bed base
- › non-magnetic base
- › electric adjustable base
- › bed frame flush with the mattress

Mattress sold separately

- › see the catalogue The Art of Sleeping www.orizzontiitalia.it

Lit rembourré avec revêtement amovible

- › tissu
- › cuir
- › similcuir

De série

- › cadre de lit à l'extérieur du matelas
- › pieds en bois
- › sommier à lattes

Options

- › coffre avec sommier relevable à double ouverture
- › sommier à lattes amorties
- › plateau orthopédique
- › sommier non magnétique
- › sommier motorisé
- › cadre de lit au ras du matelas

Matelas vendu séparément

- › voir le catalogue The Art of Sleeping www.orizzontiitalia.it

Gepolstertes Bett mit abnehmbarem Bezug

- › Stoff
- › Leder
- › Kunstleder

Serienausstattung

- › Bettrahmen außerhalb der Matratze
- › Holzfüße
- › Lattenrost

Optionale Ausstattung

- › Bettkasten mit zwei verschiedene Liffunktionen
- › gefederter Lattenrost
- › orthopädische Basis
- › Holzrahmen Lattenrost
- › motorischer Lattenrost
- › Bettrahmen bündig zur Matratze

Matratze separat erhältlich

- › zum Katalog The Art of Sleeping www.orizzontiitalia.it

Cama tapizada con revestimiento amovible

- › tejido
- › piel
- › ecopiel

De serie

- › marco de la cama fuera del colchón
- › patas de madera
- › somier de lamas

Opcionales

- › arcón con somier elevable de doble abertura
- › lamas amortiguadas
- › somier ortopédico
- › somier no magnético
- › somier motorizado
- › marco de la cama a ras del colchón

Colchón

- › se vende por separado
- › consultar el catálogo The Art of Sleeping www.orizzontiitalia.it



110 / 120 / 140 / 160 / 180 /
190 / 200 / 220 / 67.7" / 83.9"

10

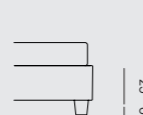
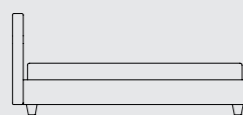
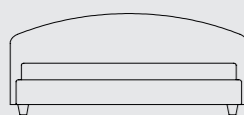

101 / 111 / 131 / 151 / 171 /
181 / 191 / 211 / 64.2" / 80.3"

217 / 86.6" / 86.6"

Materasso Mattress (cm)	Ingombro Bed size (cm)
90 x 200	110 x 217 x 94H
100 x 200	120 x 217 x 94H
120 x 200	140 x 217 x 94H
140 x 200	160 x 217 x 94H
160 x 200	180 x 217 x 94H
170 x 200	190 x 217 x 94H
180 x 200	200 x 217 x 94H
200 x 200	220 x 217 x 94H
American Queen Size 60" x 80"	67.7" x 86.6" x 37.0"H
American King Size 76" x 80"	83.9" x 86.6" x 37.0"H

Letto imbottito con rivestimento sfoderabile

- › tessuto
- › ecopelle

Di serie

- › giroletto esterno al materasso
- › piedi in legno
- › rete a doghe

Optional

- › vano contenitore con rete alzabile a doppia apertura
- › doghe ammortizzate
- › piano ortopedico
- › rete amagnetica
- › rete motorizzata
- › giroletto a filo del materasso

Materasso venduto a parte

- › consulta il catalogo The Art of Sleeping www.orizzontiitalia.it

Upholstered bed with removable cover

- › fabric
- › faux leather

Standard

- › bed frame outside the mattress
- › wooden feet
- › slatted base

Optionals

- › storage compartment with double opening lifttable base
- › sprung slats
- › orthopaedic bed base
- › non-magnetic base
- › electric adjustable base
- › bed frame flush with the mattress

Mattress sold separately

- › see the catalogue The Art of Sleeping www.orizzontiitalia.it

Lit rembourré avec revêtement amovible

- › tissu
- › similcuir

De série

- › cadre de lit à l'extérieur du matelas
- › pieds en bois
- › sommier à lattes

Options

- › coffre avec sommier relevable à double ouverture
- › sommier à lattes amorties
- › plateau orthopédique
- › sommier non magnétique
- › sommier motorisé
- › cadre de lit au ras du matelas

Matelas vendu séparément

- › voir le catalogue The Art of Sleeping www.orizzontiitalia.it

Gepolstertes Bett mit abnehmbarem Bezug

- › Stoff
- › Kunstleder

Serienausstattung

- › Bettrahmen außerhalb der Matratze
- › Holzfüße
- › Lattenrost

Optionale Ausstattung

- › Bettkasten mit zwei verschiedene Liffunktionen
- › gefederter Lattenrost
- › orthopädische Basis
- › Holzrahmen Lattenrost
- › motorischer Lattenrost
- › Bettrahmen bündig zur Matratze

Matratze separat erhältlich

- › zum Katalog The Art of Sleeping www.orizzontiitalia.it

Cama tapizada con revestimiento amovible

- › tejido
- › ecopiel

De serie

- › marco de la cama fuera del colchón
- › patas de madera
- › somier de lamas

Opcionales

- › arcón con somier elevable de doble abertura
- › lamas amortiguadas
- › somier ortopédico
- › somier no magnético
- › somier motorizado
- › marco de la cama a ras del colchón

Colchón

- › se vende por separado
- › consultar el catálogo The Art of Sleeping www.orizzontiitalia.it



110 / 120 / 140 / 160 / 180 /
190 / 200 / 220 / 67.7" / 83.9"

10

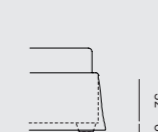
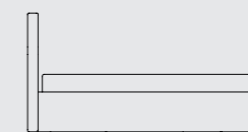
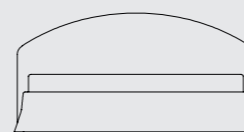

101 / 111 / 131 / 151 / 171 /
181 / 191 / 211 / 64.2" / 80.3"

217 / 86.6" / 86.6"

Materasso Mattress (cm)	Ingombro Bed size (cm)
90 x 200	110 x 217 x 110H
100 x 200	120 x 217 x 110H
120 x 200	140 x 217 x 110H
140 x 200	160 x 217 x 110H
160 x 200	180 x 217 x 110H
170 x 200	190 x 217 x 110H
180 x 200	200 x 217 x 110H
200 x 200	220 x 217 x 110H
American Queen Size 60" x 80"	67.7" x 86.6" x 43.3"H
American King Size 76" x 80"	83.9" x 86.6" x 43.3"H

Letto imbottito con rivestimento sfoderabile

- › tessuto
- › pelle
- › ecopelle

Upholstered bed with removable cover

- › fabric
- › leather
- › faux leather

Lit rembourré avec revêtement amovible

- › tissu
- › cuir
- › similcuir

Gepolstertes Bett mit abnehmbarem Bezug

- › Stoff
- › Leder
- › Kunstleder

Cama tapizada con revestimiento amovible

- › tejido
- › piel
- › ecopiel

Di serie

- › giroletto esterno al materasso
- › piedi in legno
- › rete a doghe

Standard

- › bed frame outside the mattress
- › wooden feet
- › slatted base

De série

- › cadre de lit à l'extérieur du matelas
- › pieds en bois
- › sommier à lattes

Serienausstattung

- › Bettrahmen außerhalb der Matratze
- › Holzfüße
- › Lattenrost

De serie

- › marco de la cama fuera del colchón
- › patas de madera
- › somier de lamas

Optional

- › vano contenitore con rete alzabile a doppia apertura
- › doghe ammortizzate
- › piano ortopedico
- › rete amagnetica
- › rete motorizzata
- › giroletto a filo del materasso

Optionals

- › storage compartment with double opening lifttable base
- › sprung slats
- › orthopaedic bed base
- › non-magnetic base
- › electric adjustable base
- › bed frame flush with the mattress

Options

- › coffre avec sommier relevable à double ouverture
- › sommier à lattes amorties
- › plateau orthopédique
- › sommier non magnétique
- › sommier motorisé
- › cadre de lit au ras du matelas

Optionale Ausstattung

- › Bettkasten mit zwei verschiedene Liffunktionen
- › gefederter Lattenrost
- › orthopädische Basis
- › Holzrahmen Lattenrost
- › motorischer Lattenrost
- › Bettrahmen bündig zur Matratze

Opcionales

- › arcón con somier elevable de doble abertura
- › lamas amortiguadas
- › somier ortopédico
- › somier no magnético
- › somier motorizado
- › marco de la cama a ras del colchón

Materasso venduto a parte

- › consulta il catalogo The Art of Sleeping www.orizzontiitalia.it

Mattress sold separately

- › see the catalogue The Art of Sleeping www.orizzontiitalia.it

Matelas vendu séparément

- › voir le catalogue The Art of Sleeping www.orizzontiitalia.it

Matratze separat erhältlich

- › zum Katalog The Art of Sleeping www.orizzontiitalia.it

Colchón

- › se vende por separado
- › consultar el catálogo The Art of Sleeping www.orizzontiitalia.it

Letto imbottito con rivestimento sfoderabile

- › tessuto
- › pelle
- › ecopelle

Upholstered bed with removable cover

- › fabric
- › leather
- › faux leather

Lit rembourré avec revêtement amovible

- › tissu
- › cuir
- › similcuir

Gepolstertes Bett mit abnehmbarem Bezug

- › Stoff
- › Leder
- › Kunstleder

Cama tapizada con revestimiento amovible

- › tejido
- › piel
- › ecopiel

Di serie

- › giroletto esterno al materasso
- › piedi in legno
- › rete superiore a doghe
- › rete estraibile in legno

Standard

- › bed frame outside the mattress
- › wooden feet
- › upper slatted base
- › wooden pull-out base

De série

- › cadre de lit à l'extérieur du matelas
- › pieds en bois
- › sommier à lattes
- › sommier extractible en bois

Serienausstattung

- › Bettrahmen außerhalb der Matratze
- › Holzfüße
- › oberer Lattenrost
- › ausziehbarer Holzlattenrost

De serie

- › marco de la cama fuera del colchón
- › patas de madera
- › somier de lamas
- › sommier extraible en madera

Materasso venduto a parte

- › materasso superiore: consulta il catalogo The Art of Sleeping www.orizzontiitalia.it
- › materasso inferiore: Sit & Sleep Standard Sit & Sleep Memory

Mattress sold separately

- › upper mattress: see the catalogue The Art of Sleeping www.orizzontiitalia.it
- › lower mattress: Sit & Sleep Standard Sit & Sleep Memory

Matelas vendu séparément

- › matelas supérieur: voir le catalogue The Art of Sleeping www.orizzontiitalia.it
- › matelas inférieur: Sit & Sleep Standard Sit & Sleep Memory

Matratze separat erhältlich

- › Obermatratze: zum Katalog The Art of Sleeping www.orizzontiitalia.it
- › Untermatratze: Sit & Sleep Standard Sit & Sleep Memory

Colchón se vende por separado

- › colchón superior: consultar el catálogo The Art of Sleeping www.orizzontiitalia.it
- › colchón inferior: Sit & Sleep Standard Sit & Sleep Memory



Materasso Mattress (cm)	Ingombro Bed size (cm)
90 x 200	106 x 217 x 90H
100 x 200	116 x 217 x 90H
120 x 200	136 x 217 x 90H
140 x 200	156 x 217 x 90H
160 x 200	176 x 217 x 90H
170 x 200	186 x 217 x 90H
180 x 200	196 x 217 x 90H
200 x 200	216 x 217 x 90H
American Queen Size 60" x 80"	66.1" x 86.6" x 35.4"H
American King Size 76" x 80"	82.3" x 86.6" x 35.4"H



Materasso Mattress (cm)	Ingombro Bed size (cm)
90 x 200	106 x 220 x 90H
100 x 200	116 x 220 x 90H

106 / 116 / 136 / 156 / 176 / 186 / 196 / 216 / 66.1" / 82.3"

10

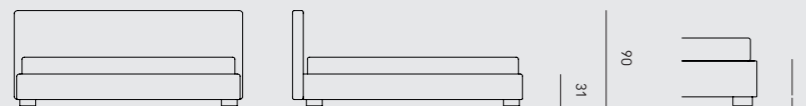

101 / 111 / 131 / 151 / 171 / 181 / 191 / 211 / 64.2" / 80.3"

217 / 86.6" / 86.6"

106 / 116

10

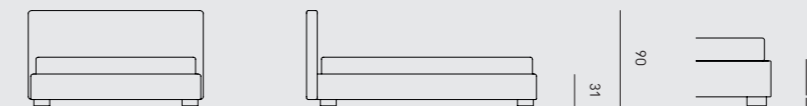

101 / 111

220

Letto imbottito con rivestimento sfoderabile

- › tessuto
- › pelle
- › ecopelle

Di serie

- › giroletto esterno al materasso
- › piedi in legno
- › rete a doghe

Optional

- › vano contenitore con rete alzabile a doppia apertura
- › doghe ammortizzate
- › piano ortopedico
- › rete amagnetica
- › rete motorizzata
- › giroletto a filo del materasso

Materasso venduto a parte

- › consulta il catalogo The Art of Sleeping www.orizzontiitalia.it

Upholstered bed with removable cover

- › fabric
- › leather
- › faux leather

Standard

- › bed frame outside the mattress
- › wooden feet
- › slatted base

Optionals

- › storage compartment with double opening
- › lifttable base
- › sprung slats
- › orthopaedic bed base
- › non-magnetic base
- › electric adjustable base
- › bed frame flush with the mattress

Mattress sold separately

- › see the catalogue The Art of Sleeping www.orizzontiitalia.it

Lit rembourré avec revêtement amovible

- › tissu
- › cuir
- › similcuir

De série

- › cadre de lit à l'extérieur du matelas
- › pieds en bois
- › sommier à lattes

Options

- › coffre avec sommier relevable à double ouverture
- › sommier à lattes amorties
- › plateau orthopédique
- › sommier non magnétique
- › sommier motorisé
- › cadre de lit au ras du matelas

Matelas vendu séparément

- › voir le catalogue The Art of Sleeping www.orizzontiitalia.it

Gepolstertes Bett mit abnehmbarem Bezug

- › Stoff
- › Leder
- › Kunstleder

Serienausstattung

- › Bettrahmen außerhalb der Matratze
- › Holzfüße
- › Lattenrost

Optionale Ausstattung

- › Bettkasten mit zwei verschiedene Liffunktionen
- › gefederter Lattenrost
- › orthopädische Basis
- › Holzrahmen Lattenrost
- › motorischer Lattenrost
- › Bettrahmen bündig zur Matratze

Matratze separat erhältlich

- › zum Katalog The Art of Sleeping www.orizzontiitalia.it

Cama tapizada con revestimiento amovible

- › tejido
- › piel
- › ecopiel

De serie

- › marco de la cama fuera del colchón
- › patas de madera
- › somier de lamas

Opcionales

- › arcón con somier elevable de doble abertura
- › lamas amortiguadas
- › somier ortopédico
- › somier no magnético
- › somier motorizado
- › marco de la cama a ras del colchón

Colchón

- › se vende por separado
- › consultar el catálogo The Art of Sleeping www.orizzontiitalia.it



Materasso Mattress (cm)	Ingombro Bed size (cm)
90 x 200	106 x 217 x 105H
100 x 200	116 x 217 x 105H
120 x 200	136 x 217 x 105H
140 x 200	156 x 217 x 105H
160 x 200	176 x 217 x 105H
170 x 200	186 x 217 x 105H
180 x 200	196 x 217 x 105H
200 x 200	216 x 217 x 105H
American Queen Size 60" x 80"	66.1" x 86.6" x 41.3"H
American King Size 76" x 80"	82.3" x 86.6" x 41.3"H

106 / 116 / 136 / 156 / 176 / 186 / 196 / 216 / 66.1" / 82.3"

10

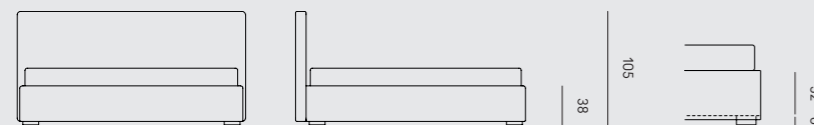

101 / 111 / 131 / 151 / 171 / 181 / 191 / 211 / 64.2" / 80.3"

217 / 86.6" / 86.6"

Letto imbottito con rivestimento sfoderabile

- › tessuto
- › ecopelle

Di serie

- › giroletto a filo del materasso
- › piedi in metallo
- › rete a doghe

Materasso venduto a parte

- › consulta il catalogo The Art of Sleeping www.orizzontiitalia.it

Upholstered bed with removable cover

- › fabric
- › faux leather

Standard

- › bed frame flush with the mattress
- › metal feet
- › slatted base

Mattress sold separately

- › see the catalogue The Art of Sleeping www.orizzontiitalia.it

Lit rembourré avec revêtement amovible

- › tissu
- › similcuir

De série

- › cadre de lit au ras du matelas
- › pieds en métal
- › sommier à lattes

Matelas vendu séparément

- › voir le catalogue The Art of Sleeping www.orizzontiitalia.it

Gepolstertes Bett mit abnehmbarem Bezug

- › Stoff
- › Kunstleder

Serienausstattung

- › Bettrahmen bündig zur Matratze
- › Metallfüße
- › Lattenrost

Matratze separat erhältlich

- › zum Katalog The Art of Sleeping www.orizzontiitalia.it

Cama tapizada con revestimiento amovible

- › tejido
- › ecopiel

De serie

- › marco de la cama a ras del colchón
- › patas de metal
- › somier de lamas

Colchón

- › se vende por separado
- › consultar el catálogo The Art of Sleeping www.orizzontiitalia.it



Materasso Mattress (cm)	Ingombro Bed size (cm)
100 x 200	104 x 234 x 119H
160 x 200	164 x 234 x 119H
170 x 200	174 x 234 x 119H
180 x 200	184 x 234 x 119H

104 / 164 / 174 / 184

30

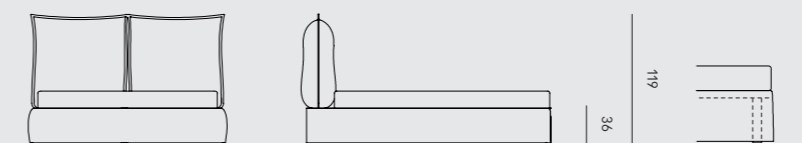

104 / 164 / 174 / 184

234

Letto imbottito con rivestimento sfoderabile
 › tessuto
 › ecopelle

Upholstered bed with removable cover
 › fabric
 › faux leather

Lit rembourré avec revêtement amovible
 › tissu
 › similcuir

Gepolstertes Bett mit abnehmbarem Bezug
 › Stoff
 › Kunstleder

Cama tapizada con revestimiento amovible
 › tejido
 › ecopiel

Di serie
 › giroletto a filo del materasso
 › piedi in abs
 › rete a doghe
 › vano contenitore con rete alzabile a doppia apertura

Standard
 › bed frame flush with the mattress
 › abs feet
 › slatted base
 › storage compartment with double opening liftable base

De série
 › cadre de lit au ras du matelas
 › pieds en ABS
 › sommier à lattes
 › coffre avec sommier relevable à double ouverture

Serienausstattung
 › Bettrahmen bündig zur Matratze
 › ABS Füße
 › Lattenrost
 › Bettkasten mit zwei verschiedene Liffunktionen

De serie
 › marco de la cama a ras del colchón
 › patas de abs
 › somier de lamas
 › arcón con somier elevable de doble abertura

Materasso venduto a parte
 › consulta il catalogo
 The Art of Sleeping
 www.orizzontiitalia.it

Mattress sold separately
 › see the catalogue
 The Art of Sleeping
 www.orizzontiitalia.it

Matelas vendu séparément
 › voir le catalogue
 The Art of Sleeping
 www.orizzontiitalia.it

Matratze separat erhältlich
 › zum Katalog
 The Art of Sleeping
 www.orizzontiitalia.it

Colchón se vende por separado
 › consultar el catálogo
 The Art of Sleeping
 www.orizzontiitalia.it



Materasso Mattress (cm)	Ingombro Bed size (cm)
160 x 200	164 x 234 x 119H
170 x 200	174 x 234 x 119H
180 x 200	184 x 234 x 119H

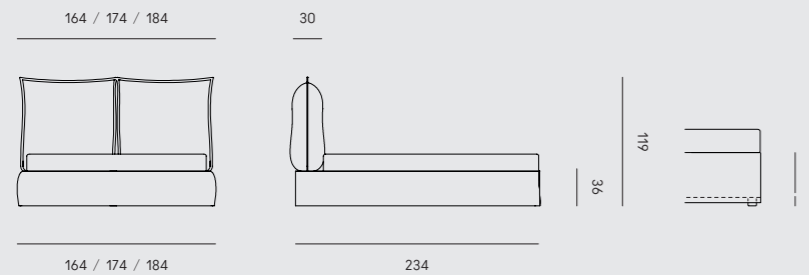

Finitura
 › rovere moca
 › rovere bianco

Finish
 › mocha oak
 › white oak

Finition
 › chêne moka
 › chêne blanc

Ausführung
 › Eiche Mokka
 › Eiche Weiß

Acabado
 › roble moca
 › roble blanco

Testiera imbottita con rivestimento sfoderabile
 › tessuto
 › pelle
 › ecopelle

Upholstered headboard with removable cover
 › fabric
 › leather
 › faux leather

Tête de lit rembourré avec revêtement amovible
 › tissu
 › cuir
 › similcuir

Gepolsterter Kopfteil mit abnehmbarem Bezug
 › Stoff
 › Leder
 › Kunstleder

Cabecero tapizado con revestimiento amovible
 › tejido
 › piel
 › ecopiel

Varianti
 › piedi H40 cm (Basso)
 › piedi H50 cm (Alto)

Variants
 › feet H40 cm (Low)
 › feet H50 cm (High)

Variantes
 › pieds H40 cm (Bas)
 › pieds H50 cm (Haut)

Varianten
 › Beine H40 cm (Klein)
 › Beine H50 cm (Hoch)

Variantes
 › patas H40 cm (Bajo)
 › patas H50 cm (Alto)

Di serie
 › rete a doghe

Standard
 › slatted base

De série
 › sommier à lattes

Serienausstattung
 › Lattenrost

De serie
 › somier de lamas

Materasso venduto a parte
 › consulta il catalogo
 The Art of Sleeping
 www.orizzontiitalia.it

Mattress sold separately
 › see the catalogue
 The Art of Sleeping
 www.orizzontiitalia.it

Matelas vendu séparément
 › voir le catalogue
 The Art of Sleeping
 www.orizzontiitalia.it

Matratze separat erhältlich
 › zum Katalog
 The Art of Sleeping
 www.orizzontiitalia.it

Colchón se vende por separado
 › consultar el catálogo
 The Art of Sleeping
 www.orizzontiitalia.it



Materasso Mattress (cm)	Ingombro Bed size (cm)
160 x 200	175 x 235 x 110 / 120H
170 x 200	185 x 235 x 110 / 120H
180 x 200	195 x 235 x 110 / 120H

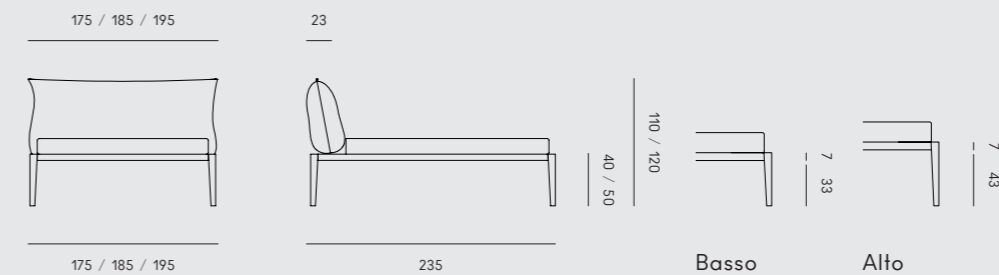

Finitura

- › rovere moca
- › rovere bianco

Finish

- › mocha oak
- › white oak

Finition

- › chêne moka
- › chêne blanc

Ausführung

- › Eiche Mokka
- › Eiche Weiß

Acabado

- › roble moca
- › roble blanco

Testiera imbottita con rivestimento sfoderabile

- › tessuto
- › pelle
- › ecopelle

Upholstered headboard with removable cover

- › fabric
- › leather
- › faux leather

Tête de lit rembourré avec revêtement amovible

- › tissu
- › cuir
- › similcuir

Gepolsterter Kopfteil mit abnehmbarem Bezug

- › Stoff
- › Leder
- › Kunstleder

Cabecero tapizado con revestimiento amovible

- › tejido
- › piel
- › ecopiel

Di serie

- › rete a doghe

Standard

- › slatted base

De série

- › sommier à lattes

Serienausstattung

- › Lattenrost

De serie

- › somier de lamas

Materasso venduto a parte

- › consulta il catalogo
- The Art of Sleeping
- www.orizzontiitalia.it

Mattress sold separately

- › see the catalogue
- The Art of Sleeping
- www.orizzontiitalia.it

Matelas vendu séparément

- › voir le catalogue
- The Art of Sleeping
- www.orizzontiitalia.it

Matratze separat erhältlich

- › zum Katalog
- The Art of Sleeping
- www.orizzontiitalia.it

Colchón se vende por separado

- › consultar el catálogo
- The Art of Sleeping
- www.orizzontiitalia.it

Finitura

- › rovere moca
- › rovere bianco

Finish

- › mocha oak
- › white oak

Finition

- › chêne moka
- › chêne blanc

Ausführung

- › Eiche Mokka
- › Eiche Weiß

Acabado

- › roble moca
- › roble blanco

Rullo

- › tessuto
- › pelle
- › ecopelle

Bolster

- › fabric
- › leather
- › faux leather

Traversin

- › tissu
- › cuir
- › similcuir

Kissenrolle

- › Stoff
- › Leder
- › Kunstleder

Cojin cilíndrico

- › tejido
- › piel
- › ecopiel

Varianti

- › piedi H40 cm (Basso)
- › piedi H50 cm (Alto)

Variants

- › feet H40 cm (Low)
- › feet H50 cm (High)

Variantes

- › pieds H40 cm (Bas)
- › pieds H50 cm (Haut)

Varianten

- › Beine H40 cm (Klein)
- › Beine H50 cm (Hoch)

Variantes

- › patas H40 cm (Bajo)
- › patas H50 cm (Alto)

Di serie

- › rete a doghe

Standard

- › slatted base

De série

- › sommier à lattes

Serienausstattung

- › Lattenrost

De serie

- › somier de lamas

Materasso venduto a parte

- › consulta il catalogo
- The Art of Sleeping
- www.orizzontiitalia.it

Mattress sold separately

- › see the catalogue
- The Art of Sleeping
- www.orizzontiitalia.it

Matelas vendu séparément

- › voir le catalogue
- The Art of Sleeping
- www.orizzontiitalia.it

Matratze separat erhältlich

- › zum Katalog
- The Art of Sleeping
- www.orizzontiitalia.it

Colchón

- › se vende por separado
- › consultar el catálogo
- The Art of Sleeping
- www.orizzontiitalia.it



Materasso Mattress (cm)	Ingombro Bed size (cm)
160 x 200	175 x 235 x 205H
170 x 200	185 x 235 x 205H
180 x 200	195 x 235 x 205H



Materasso Mattress (cm)	Ingombro Bed size (cm)
160 x 200	175 x 230 x 40 / 50H
170 x 200	185 x 230 x 40 / 50H
180 x 200	195 x 230 x 40 / 50H

175 / 185 / 195

23

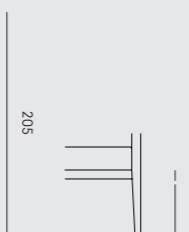
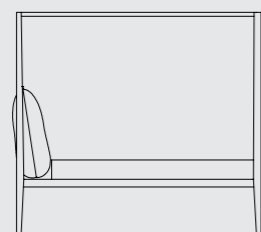
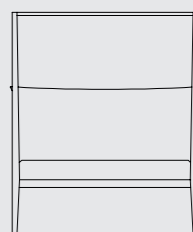

175 / 185 / 195

235

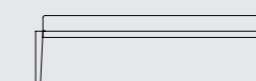
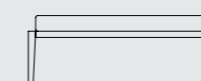

175 / 185 / 195

230

Basso

Alto

Letto imbottito con rivestimento sfoderabile

- › tessuto
- › pelle
- › ecopelle

Upholstered bed with removable cover

- › fabric
- › leather
- › faux leather

Lit rembourré avec revêtement amovible

- › tissu
- › cuir
- › similcuir

Gepolstertes Bett mit abnehmbarem Bezug

- › Stoff
- › Leder
- › Kunstleder

Cama tapizada con revestimiento amovible

- › tejido
- › piel
- › ecopiel

Di serie

- › giroletto esterno al materasso
- › piedi in abs
- › rete a doghe

Standard

- › bed frame outside the mattress
- › abs feet
- › slatted base

De série

- › cadre de lit à l'extérieur du matelas
- › pieds en ABS
- › sommier à lattes

Serienausstattung

- › Bettrahmen außerhalb der Matratze
- › ABS Füße
- › Lattenrost

De serie

- › marco de la cama fuera del colchón
- › patas de abs
- › somier de lamas

Optional

- › vano contenitore con rete alzabile a doppia apertura
- › doghe ammortizzate
- › piano ortopedico
- › rete amagnetica
- › rete motorizzata

Optionals

- › storage compartment with double opening
- › liftable base
- › sprung slats
- › orthopaedic bed base
- › non-magnetic base
- › electric adjustable base

Options

- › coffre avec sommier relevable à double ouverture
- › sommier à lattes amorties
- › plateau orthopédique
- › sommier non magnétique
- › sommier motorisé

Optionale Ausstattung

- › Bettkasten mit zwei verschiedene Liffunktionen
- › gefederter Lattenrost
- › orthopädische Basis
- › Holzrahmen Lattenrost
- › motorischer Lattenrost

Opcionales

- › arcón con somier elevable de doble abertura
- › lamas amortiguadas
- › somier ortopédico
- › somier no magnético
- › somier motorizado

Materasso venduto a parte

- › consulta il catalogo The Art of Sleeping www.orizzontiitalia.it

Mattress sold separately

- › see the catalogue The Art of Sleeping www.orizzontiitalia.it

Matelas vendu séparément

- › voir le catalogue The Art of Sleeping www.orizzontiitalia.it

Matratze separat erhältlich

- › zum Katalog The Art of Sleeping www.orizzontiitalia.it

Colchón

- › se vende por separado The Art of Sleeping www.orizzontiitalia.it

Letto imbottito con rivestimento sfoderabile

- › tessuto
- › pelle
- › ecopelle

Upholstered bed with removable cover

- › fabric
- › leather
- › faux leather

Lit rembourré avec revêtement amovible

- › tissu
- › cuir
- › similcuir

Gepolstertes Bett mit abnehmbarem Bezug

- › Stoff
- › Leder
- › Kunstleder

Cama tapizada con revestimiento amovible

- › tejido
- › piel
- › ecopiel

Di serie

- › giroletto esterno al materasso
- › piedi in legno
- › rete a doghe

Standard

- › bed frame outside the mattress
- › wooden feet
- › slatted base

De série

- › cadre de lit à l'extérieur du matelas
- › pieds en bois
- › sommier à lattes

Serienausstattung

- › Bettrahmen außerhalb der Matratze
- › Holzfüße
- › Lattenrost

De serie

- › marco de la cama fuera del colchón
- › patas de madera
- › somier de lamas

Optional

- › vano contenitore con rete alzabile a doppia apertura
- › doghe ammortizzate
- › piano ortopedico
- › rete amagnetica
- › rete motorizzata
- › giroletto a filo del materasso

Optionals

- › storage compartment with double opening
- › liftable base
- › sprung slats
- › orthopaedic bed base
- › non-magnetic base
- › electric adjustable base
- › bed frame flush with the mattress

Options

- › coffre avec sommier relevable à double ouverture
- › sommier à lattes amorties
- › plateau orthopédique
- › sommier non magnétique
- › sommier motorisé
- › cadre de lit au ras du matelas

Optionale Ausstattung

- › Bettkasten mit zwei verschiedene Liffunktionen
- › gefederter Lattenrost
- › orthopädische Basis
- › Holzrahmen Lattenrost
- › motorischer Lattenrost
- › Bettrahmen bündig zur Matratze

Opcionales

- › arcón con somier elevable de doble abertura
- › lamas amortiguadas
- › somier ortopédico
- › somier no magnético
- › somier motorizado
- › marco de la cama a ras del colchón

Materasso venduto a parte

- › consulta il catalogo The Art of Sleeping www.orizzontiitalia.it

Mattress sold separately

- › see the catalogue The Art of Sleeping www.orizzontiitalia.it

Matelas vendu séparément

- › voir le catalogue The Art of Sleeping www.orizzontiitalia.it

Matratze separat erhältlich

- › zum Katalog The Art of Sleeping www.orizzontiitalia.it

Colchón

- › se vende por separado The Art of Sleeping www.orizzontiitalia.it



Materasso Mattress (cm)	Ingombro Bed size (cm)
160 x 200	185 x 246 x 91H
170 x 200	195 x 246 x 91H
180 x 200	205 x 246 x 91H
200 x 200	225 x 246 x 91H
American Queen Size 60" x 80"	69.7" x 98.0" x 35.8"H
American King Size 76" x 80"	85.8" x 98.0" x 35.8"H



Materasso Mattress (cm)	Ingombro Bed size (cm)
160 x 200	174 x 217 x 144H
170 x 200	184 x 217 x 144H
180 x 200	194 x 217 x 144H
200 x 200	214 x 217 x 144H
American Queen Size 60" x 80"	65.4" x 86.6" x 56.7"H
American King Size 76" x 80"	81.5" x 86.6" x 56.7"H

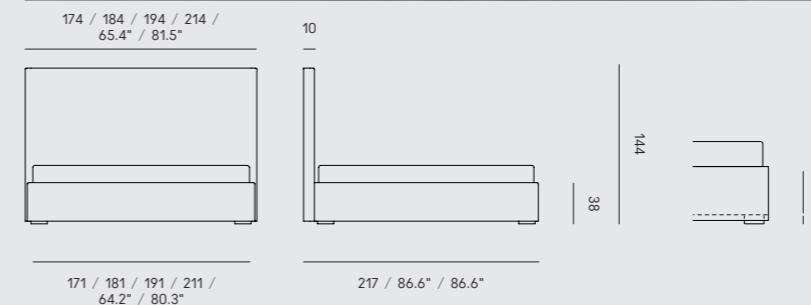
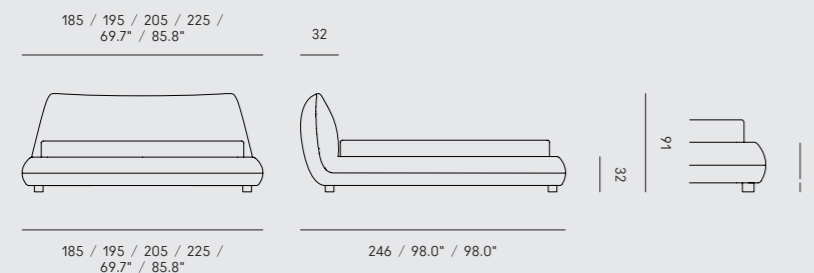

Letto imbottito con rivestimento sfoderabile

- › tessuto
- › pelle
- › ecopelle

Di serie

- › giroletto esterno al materasso
- › piedi in legno
- › rete a doghe

Optional

- › vano contenitore con rete alzabile a doppia apertura
- › doghe ammortizzate
- › piano ortopedico
- › rete amagnetica
- › rete motorizzata
- › giroletto a filo del materasso

Materasso venduto a parte

- › consulta il catalogo The Art of Sleeping www.orizzontiitalia.it

Upholstered bed with removable cover

- › fabric
- › leather
- › faux leather

Standard

- › bed frame outside the mattress
- › wooden feet
- › slatted base

Optionals

- › storage compartment with double opening liftable base
- › sprung slats
- › orthopaedic bed base
- › non-magnetic base
- › electric adjustable base
- › bed frame flush with the mattress

Mattress sold separately

- › see the catalogue The Art of Sleeping www.orizzontiitalia.it

Lit rembourré avec revêtement amovible

- › tissu
- › cuir
- › similcuir

De série

- › cadre de lit à l'extérieur du matelas
- › pieds en bois
- › sommier à lattes

Options

- › coffre avec sommier relevable à double ouverture
- › sommier à lattes amorties
- › plateau orthopédique
- › sommier non magnétique
- › sommier motorisé
- › cadre de lit au ras du matelas

Matelas vendu séparément

- › voir le catalogue The Art of Sleeping www.orizzontiitalia.it

Gepolstertes Bett mit abnehmbarem Bezug

- › Stoff
- › Leder
- › Kunstleder

Serienausstattung

- › Bettrahmen außerhalb der Matratze
- › Holzfüße
- › Lattenrost

Optionale Ausstattung

- › Bettkasten mit zwei verschiedene Liffunktionen
- › gefederter Lattenrost
- › orthopädische Basis
- › Holzrahmen Lattenrost
- › motorischer Lattenrost
- › Bettrahmen bündig zur Matratze

Matratze separat erhältlich

- › zum Katalog The Art of Sleeping www.orizzontiitalia.it

Cama tapizada con revestimiento amovible

- › tejido
- › piel
- › ecopiel

De serie

- › marco de la cama fuera del colchón
- › patas de madera
- › somier de lamas

Opcionales

- › arcón con somier elevable de doble abertura
- › lamas amortiguadas
- › somier ortopédico
- › somier no magnético
- › somier motorizado
- › marco de la cama a ras del colchón

Colchón

- › se vende por separado
- › consultar el catálogo The Art of Sleeping www.orizzontiitalia.it

Letto imbottito con rivestimento sfoderabile

- › tessuto
- › ecopelle

Di serie

- › giroletto esterno al materasso
- › piedi in legno
- › rete a doghe

Optional

- › vano contenitore con rete alzabile a doppia apertura
- › doghe ammortizzate
- › piano ortopedico
- › rete amagnetica
- › rete motorizzata
- › giroletto a filo del materasso

Materasso venduto a parte

- › consulta il catalogo The Art of Sleeping www.orizzontiitalia.it

Upholstered bed with removable cover

- › fabric
- › faux leather

Standard

- › bed frame outside the mattress
- › wooden feet
- › slatted base

Optionals

- › storage compartment with double opening liftable base
- › sprung slats
- › orthopaedic bed base
- › non-magnetic base
- › electric adjustable base
- › bed frame flush with the mattress

Mattress sold separately

- › see the catalogue The Art of Sleeping www.orizzontiitalia.it

Lit rembourré avec revêtement amovible

- › tissu
- › similcuir

De série

- › cadre de lit à l'extérieur du matelas
- › pieds en bois
- › sommier à lattes

Options

- › coffre avec sommier relevable à double ouverture
- › sommier à lattes amorties
- › plateau orthopédique
- › sommier non magnétique
- › sommier motorisé
- › cadre de lit au ras du matelas

Matelas vendu séparément

- › voir le catalogue The Art of Sleeping www.orizzontiitalia.it

Gepolstertes Bett mit abnehmbarem Bezug

- › Stoff
- › Kunstleder

Serienausstattung

- › Bettrahmen außerhalb der Matratze
- › Holzfüße
- › Lattenrost

Optionale Ausstattung

- › Bettkasten mit zwei verschiedene Liffunktionen
- › gefederter Lattenrost
- › orthopädische Basis
- › Holzrahmen Lattenrost
- › motorischer Lattenrost
- › Bettrahmen bündig zur Matratze

Matratze separat erhältlich

- › zum Katalog The Art of Sleeping www.orizzontiitalia.it

Cama tapizada con revestimiento amovible

- › tejido
- › ecopiel

De serie

- › marco de la cama fuera del colchón
- › patas de madera
- › somier de lamas

Opcionales

- › arcón con somier elevable de doble abertura
- › lamas amortiguadas
- › somier ortopédico
- › somier no magnético
- › somier motorizado
- › marco de la cama a ras del colchón

Colchón

- › se vende por separado
- › consultar el catálogo The Art of Sleeping www.orizzontiitalia.it



Materasso Mattress (cm)	Ingombro Bed size (cm)
80 x 200	91 x 211 x 38H
90 x 200	101 x 211 x 38H
100 x 200	111 x 211 x 38H
120 x 200	131 x 211 x 38H
140 x 200	151 x 211 x 38H
160 x 200	171 x 211 x 38H
170 x 200	181 x 211 x 38H
180 x 200	191 x 211 x 38H
200 x 200	211 x 211 x 38H
American Queen Size 60" x 80"	64.2" x 84.3" x 15.0"H
American King Size 76" x 80"	80.3" x 84.3" x 15.0"H



Materasso Mattress (cm)	Ingombro Bed size (cm)
160 x 200	175 x 217 x 145H
170 x 200	185 x 217 x 145H
180 x 200	195 x 217 x 145H
200 x 200	215 x 217 x 145H
American Queen Size 60" x 80"	65.7" x 86.6" x 57.1"H
American King Size 76" x 80"	81.9" x 86.6" x 57.1"H

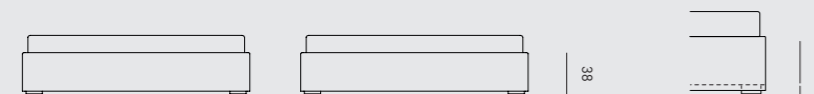
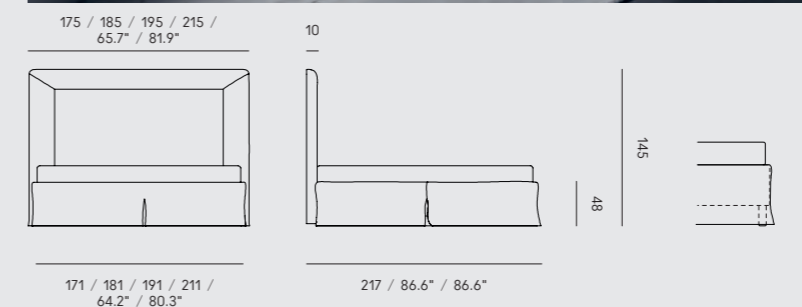

91 / 101 / 111 / 131 / 151 / 171 / 181 / 191 / 211 / 64.2" / 80.3"

211 / 84.3" / 84.3"

Letto imbottito con rivestimento sfoderabile
 › tessuto
 › ecopelle

Upholstered bed with removable cover
 › fabric
 › faux leather

Lit rembourré avec revêtement amovible
 › tissu
 › similcuir

Gepolstertes Bett mit abnehmbarem Bezug
 › Stoff
 › Kunstleder

Cama tapizada con revestimiento amovible
 › tejido
 › ecopiel

Di serie
 › giroletto esterno al materasso
 › piedi in legno
 › rete a doghe

Standard
 › bed frame outside the mattress
 › wooden feet
 › slatted base

De série
 › cadre de lit à l'extérieur du matelas
 › pieds en bois
 › sommier à lattes

Serienausstattung
 › Bettrahmen außerhalb der Matratze
 › Holzfüße
 › Lattenrost

De serie
 › marco de la cama fuera del colchón
 › patas de madera
 › somier de lamas

Optional
 › vano contenitore con rete alzabile a doppia apertura
 › doghe ammortizzate
 › piano ortopedico
 › rete amagnetica
 › rete motorizzata
 › giroletto a filo del materasso

Optionals
 › storage compartment with double opening
 › lifttable base
 › sprung slats
 › orthopaedic bed base
 › non-magnetic base
 › electric adjustable base
 › bed frame flush with the mattress

Options
 › coffre avec sommier relevable à double ouverture
 › sommier à lattes amorties
 › plateau orthopédique
 › sommier non magnétique
 › sommier motorisé
 › cadre de lit au ras du matelas

Optionale Ausstattung
 › Bettkasten mit zwei verschiedene Liffunktionen
 › gefederter Lattenrost
 › orthopädische Basis
 › Holzrahmen Lattenrost
 › motorischer Lattenrost
 › Bettrahmen bündig zur Matratze

Opcionales
 › arcón con somier elevable de doble abertura
 › lamas amortiguadas
 › somier ortopédico
 › somier no magnético
 › somier motorizado
 › marco de la cama a ras del colchón

Materasso venduto a parte
 › consulta il catalogo
 The Art of Sleeping
 www.orizzontiitalia.it

Mattress sold separately
 › see the catalogue
 The Art of Sleeping
 www.orizzontiitalia.it

Matelas vendu séparément
 › voir le catalogue
 The Art of Sleeping
 www.orizzontiitalia.it

Matratze separat erhältlich
 › zum Katalog
 The Art of Sleeping
 www.orizzontiitalia.it

Colchón se vende por separado
 › consultar el catálogo
 The Art of Sleeping
 www.orizzontiitalia.it



Materasso Mattress (cm)	Ingombro Bed size (cm)
80 x 200	91 x 211 x 48H
90 x 200	101 x 211 x 48H
100 x 200	111 x 211 x 48H
120 x 200	131 x 211 x 48H
140 x 200	151 x 211 x 48H
160 x 200	171 x 211 x 48H
170 x 200	181 x 211 x 48H
180 x 200	191 x 211 x 48H
200 x 200	211 x 211 x 48H
American Queen Size 60" x 80"	64.2" x 84.3" x 18.9"H
American King Size 76" x 80"	80.3" x 84.3" x 18.9"H

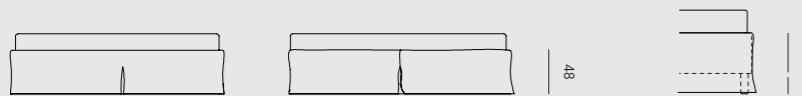

91 / 101 / 111 / 131 / 151 / 171 /
181 / 191 / 211 / 64.2" / 80.3"

211 / 84.3" / 84.3"

Finitura
 › noce canaletto
 › rovere naturale
 › rovere moca

Finish
 › walnut
 › natural oak
 › mocha oak

Finition
 › noyer
 › chêne naturel
 › chêne moka

Ausführung
 › Nussbaum
 › Eiche Natur
 › Eiche Mokka

Acabado
 › nogal
 › roble natural
 › roble moca

Varianti
 › piedi H20 cm (Basso)
 › piedi H30 cm (Alto)

Variants
 › feet H20 cm (Low)
 › feet H30 cm (High)

Variantes
 › pieds H20 cm (Bas)
 › pieds H30 cm (Haut)

Varianten
 › Beine H20 cm (Klein)
 › Beine H30 cm (Hoch)

Variantes
 › patas H20 cm (Bajo)
 › patas H30 cm (Alto)

Materasso venduto a parte
 › consulta il catalogo
 The Art of Sleeping
 www.orizzontiitalia.it

Mattress sold separately
 › see the catalogue
 The Art of Sleeping
 www.orizzontiitalia.it

Matelas vendu séparément
 › voir le catalogue
 The Art of Sleeping
 www.orizzontiitalia.it

Matratze separat erhältlich
 › zum Katalog
 The Art of Sleeping
 www.orizzontiitalia.it

Colchón se vende por separado
 › consultar el catálogo
 The Art of Sleeping
 www.orizzontiitalia.it

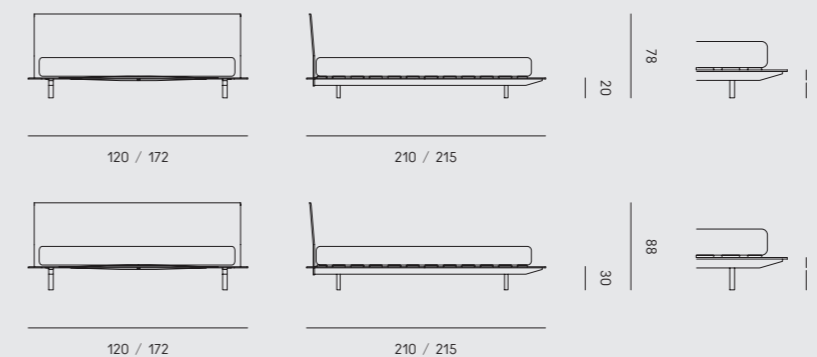

Materasso Mattress (cm)	Ingombro Bed size (cm)
90 x 200	120 x 210 x 78 / 88H
100 x 200	120 x 210 x 78 / 88H
120 x 200	120 x 210 x 78 / 88H
160 x 200	172 x 215 x 78 / 88H
170 x 200	172 x 215 x 78 / 88H

Finitura

- › noce canaletto
- › rovere naturale
- › rovere moca

Finish

- › walnut
- › natural oak
- › mocha oak

Finition

- › noyer
- › chêne naturel
- › chêne moka

Ausführung

- › Nussbaum
- › Eiche Natur
- › Eiche Mokka

Acabado

- › nogal
- › roble natural
- › roble moca

Varianti

- › piedi H20 cm (Basso)
- › piedi H30 cm (Alto)

Variants

- › feet H20 cm (Low)
- › feet H30 cm (High)

Variantes

- › pieds H20 cm (Bas)
- › pieds H30 cm (Haut)

Varianten

- › Beine H20 cm (Klein)
- › Beine H30 cm (Hoch)

Variantes

- › patas H20 cm (Bajo)
- › patas H30 cm (Alto)

Materassovenduto a parte

- › consulta il catalogo
- The Art of Sleeping
- www.orizzontiitalia.it

Mattress sold separately

- › see the catalogue
- The Art of Sleeping
- www.orizzontiitalia.it

Matelas vendu séparément

- › voir le catalogue
- The Art of Sleeping
- www.orizzontiitalia.it

Matratze separat erhältlich

- › zum Katalog
- The Art of Sleeping
- www.orizzontiitalia.it

Colchónse vende por separado

- › consultar el catálogo
- The Art of Sleeping
- www.orizzontiitalia.it

Letto imbottito con rivestimento sfoderabile

- › tessuto
- › ecopelle

Upholstered bed with removable cover

- › fabric
- › faux leather

Lit rembourré avec revêtement amovible

- › tissu
- › similcuir

Gepolstertes Bett mit abnehmbarem Bezug

- › Stoff
- › Kunstleder

Cama tapizada con revestimiento amovible

- › tejido
- › ecopiel

Cuciture

- › in tinta
- › colorate (vedi pagina 068)

Stitches

- › matching the fabric
- › coloured (see page 068)

Coutures

- › assorties
- › colorées (voir page 068)

Nähte

- › Ton-in-Ton
- › gefärbte (auf Seite 068)

Costuras

- › combinadas
- › coloradas (a página 068)

Di serie

- › giroletto esterno al materasso
- › piedi in abs
- › rete a doghe

Standard

- › bed frame outside the mattress
- › abs feet
- › slatted base

De série

- › cadre de lit à l'extérieur du matelas
- › pieds en ABS
- › sommier à lattes

Serienausstattung

- › Bettrahmen außerhalb der Matratze
- › ABS Füße
- › Lattenrost

De serie

- › marco de la cama fuera del colchón
- › patas de abs
- › somier de lamas

Optional

- › vano contenitore con rete alzabile a doppia apertura
- › doghe ammortizzate
- › piano ortopedico
- › rete amagnetica
- › rete motorizzata
- › giroletto a filo del materasso

Optionals

- › storage compartment with double opening lifttable base
- › sprung slats
- › orthopaedic bed base
- › non-magnetic base
- › electric adjustable base
- › bed frame flush with the mattress

Options

- › coffre avec sommier relevable à double ouverture
- › sommier à lattes amorties
- › plateau orthopédique
- › sommier non magnétique
- › sommier motorisé
- › cadre de lit au ras du matelas

Optionale Ausstattung

- › Bettkasten mit zwei verschiedene Liffunktionen
- › gefederter Lattenrost
- › orthopädische Basis
- › Holzrahmen Lattenrost
- › motorischer Lattenrost
- › Bettrahmen bündig zur Matratze

Opcionales

- › arcón con somier elevable de doble abertura
- › lamas amortiguadas
- › somier ortopédico
- › somier no magnético
- › somier motorizado
- › marco de la cama a ras del colchón

Materasso venduto a parte

- › www.orizzontiitalia.it

Mattress sold separately

- › www.orizzontiitalia.it

Matelas vendu séparément

- › www.orizzontiitalia.it

Matratze separat erhältlich

- › www.orizzontiitalia.it

Colchón

- › se vende por separado
- › www.orizzontiitalia.it

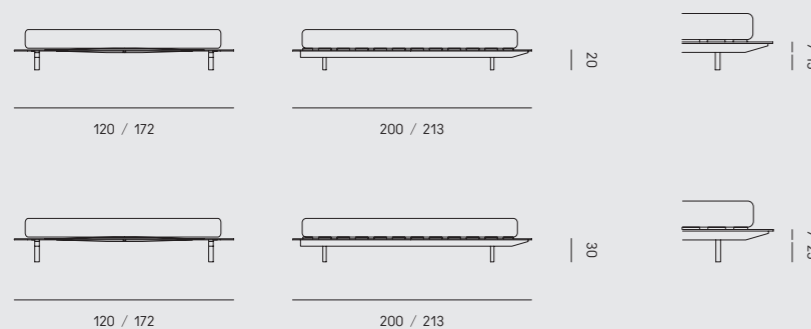

Materasso Mattress (cm)	Ingombro Bed size (cm)
90 x 200	120 x 200 x 20 / 30H
100 x 200	120 x 200 x 20 / 30H
120 x 200	120 x 200 x 20 / 30H
160 x 200	172 x 213 x 20 / 30H
170 x 200	172 x 213 x 20 / 30H

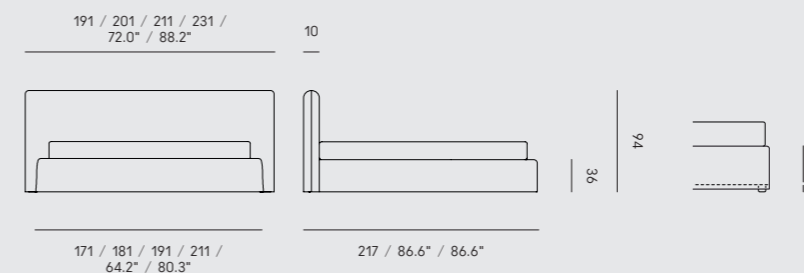

Materasso Mattress (cm)	Ingombro Bed size (cm)
160 x 200	191 x 217 x 94H
170 x 200	201 x 217 x 94H
180 x 200	211 x 217 x 94H
200 x 200	231 x 217 x 94H
American Queen Size 60" x 80"	72.0" x 86.6" x 37.0"H
American King Size 76" x 80"	88.2" x 86.6" x 37.0"H

Letto imbottito con rivestimento sfoderabile
 › tessuto
 › ecopelle

Upholstered bed with removable cover
 › fabric
 › faux leather

Lit rembourré avec revêtement amovible
 › tissu
 › similcuir

Gepolstertes Bett mit abnehmbarem Bezug
 › Stoff
 › Kunstleder

Cama tapizada con revestimiento amovible
 › tejido
 › ecopiel

Cuciture
 › in tinta
 › colorate
 (vedi pagina 068)

Stitches
 › matching the fabric
 › coloured
 (see page 068)

Coutures
 › assorties
 › colorées
 (voir page 068)

Nähte
 › Ton-in-Ton
 › gefärbte
 (auf Seite 068)

Costuras
 › combinadas
 › coloradas
 (a página 068)

Di serie
 › giroletto esterno al materasso
 › piedi in abs
 › rete a doghe

Standard
 › bed frame outside the mattress
 › abs feet
 › slatted base

De série
 › cadre de lit à l'extérieur du matelas
 › pieds en ABS
 › sommier à lattes

Serienausstattung
 › Bettrahmen außerhalb der Matratze
 › ABS Füße
 › Lattenrost

De serie
 › marco de la cama fuera del colchón
 › patas de abs
 › somier de lamas

Optional
 › vano contenitore con rete alzabile a doppia apertura
 › doghe ammortizzate
 › piano ortopedico
 › rete amagnetica
 › rete motorizzata
 › giroletto a filo del materasso

Optionals
 › storage compartment with double opening lifttable base
 › sprung slats
 › orthopaedic bed base
 › non-magnetic base
 › electric adjustable base
 › bed frame flush with the mattress

Options
 › coffre avec sommier relevable à double ouverture
 › sommier à lattes amorties
 › plateau orthopédique
 › sommier non magnétique
 › sommier motorisé
 › cadre de lit au ras du matelas

Optionale Ausstattung
 › Bettkasten mit zwei verschiedene Liffunktionen
 › gefederter Lattenrost
 › orthopädische Basis
 › Holzrahmen Lattenrost
 › motorischer Lattenrost
 › Bettrahmen bündig zur Matratze

Opcionales
 › arcón con somier elevable de doble abertura
 › lamas amortiguadas
 › somier ortopédico
 › somier no magnético
 › somier motorizado
 › marco de la cama a ras del colchón

Materasso venduto a parte
 › www.orizzontiitalia.it

Mattress sold separately
 › www.orizzontiitalia.it

Matelas vendu séparément
 › www.orizzontiitalia.it

Matratze separat erhältlich
 › www.orizzontiitalia.it

Colchón se vende por separado
 › www.orizzontiitalia.it



Materasso Mattress (cm)	Ingombro Bed size (cm)
160 x 200	191 x 217 x 136H
170 x 200	201 x 217 x 136H
180 x 200	211 x 217 x 136H
200 x 200	231 x 217 x 136H
American Queen Size 60" x 80"	72.0" x 86.6" x 53.5"H
American King Size 76" x 80"	88.2" x 86.6" x 53.5"H

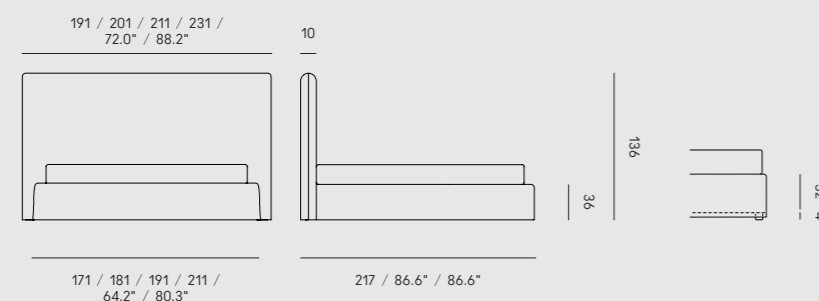

Letto imbottito con rivestimento sfoderabile
 › tessuto
 › ecopelle

Upholstered bed with removable cover
 › fabric
 › faux leather

Lit rembourré avec revêtement amovible
 › tissu
 › similcuir

Gepolstertes Bett mit abnehmbarem Bezug
 › Stoff
 › Kunstleder

Cama tapizada con revestimiento amovible
 › tejido
 › ecopiel

Cuciture
 › in tinta
 › colorate
 (vedi pagina 068)

Stitches
 › matching the fabric
 › coloured
 (see page 068)

Coutures
 › assorties
 › colorées
 (voir page 068)

Nähte
 › Ton-in-Ton
 › gefärbte
 (auf Seite 068)

Costuras
 › combinadas
 › coloradas
 (a página 068)

Di serie
 › giroletto esterno al materasso
 › piedi in abs
 › rete a doghe

Standard
 › bed frame outside the mattress
 › abs feet
 › slatted base

De série
 › cadre de lit à l'extérieur du matelas
 › pieds en ABS
 › sommier à lattes

Serienausstattung
 › Bettrahmen außerhalb der Matratze
 › ABS Füße
 › Lattenrost

De serie
 › marco de la cama fuera del colchón
 › patas de abs
 › somier de lamas

Optional
 › vano contenitore con rete alzabile a doppia apertura
 › doghe ammortizzate
 › piano ortopedico
 › rete amagnetica
 › rete motorizzata
 › giroletto a filo del materasso

Optionals
 › storage compartment with double opening lifttable base
 › sprung slats
 › orthopaedic bed base
 › non-magnetic base
 › electric adjustable base
 › bed frame flush with the mattress

Options
 › coffre avec sommier relevable à double ouverture
 › sommier à lattes amorties
 › plateau orthopédique
 › sommier non magnétique
 › sommier motorisé
 › cadre de lit au ras du matelas

Optionale Ausstattung
 › Bettkasten mit zwei verschiedene Liffunktionen
 › gefederter Lattenrost
 › orthopädische Basis
 › Holzrahmen Lattenrost
 › motorischer Lattenrost
 › Bettrahmen bündig zur Matratze

Opcionales
 › arcón con somier elevable de doble abertura
 › lamas amortiguadas
 › somier ortopédico
 › somier no magnético
 › somier motorizado
 › marco de la cama a ras del colchón

Materasso venduto a parte
 › www.orizzontiitalia.it

Mattress sold separately
 › www.orizzontiitalia.it

Matelas vendu séparément
 › www.orizzontiitalia.it

Matratze separat erhältlich
 › www.orizzontiitalia.it

Colchón se vende por separado
 › www.orizzontiitalia.it



Materasso Mattress (cm)	Ingombro Bed size (cm)
80 x 200	91 x 211 x 36H
90 x 200	101 x 211 x 36H
100 x 200	111 x 211 x 36H
120 x 200	131 x 211 x 36H
140 x 200	151 x 211 x 36H
160 x 200	171 x 211 x 36H
170 x 200	181 x 211 x 36H
180 x 200	191 x 211 x 36H
200 x 200	211 x 211 x 36H
American Queen Size 60" x 80"	64.2" x 84.3" x 14.2"H
American King Size 76" x 80"	80.3" x 84.3" x 14.2"H

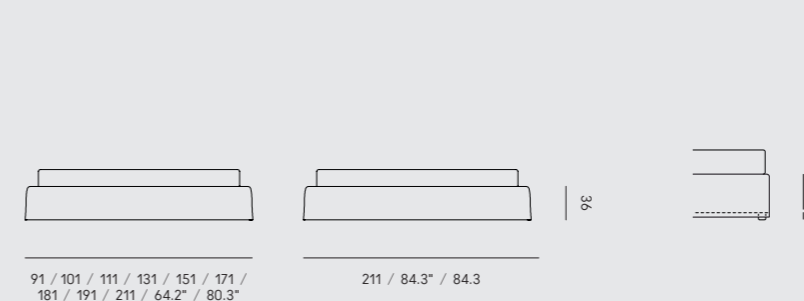

Letto imbottito con rivestimento sfoderabile
 › tessuto
 › ecopelle

Upholstered bed with removable cover
 › fabric
 › faux leather

Lit rembourré avec revêtement amovible
 › tissu
 › similcuir

Gepolstertes Bett mit abnehmbarem Bezug
 › Stoff
 › Kunstleder

Cama tapizada con revestimiento amovible
 › tejido
 › ecopiel

Di serie
 › giroletto esterno al materasso
 › piedi in legno
 › rete a doghe

Standard
 › bed frame outside the mattress
 › wooden feet
 › slatted base

De série
 › cadre de lit à l'extérieur du matelas
 › pieds en bois
 › sommier à lattes

Serienausstattung
 › Bettrahmen außerhalb der Matratze
 › Holzfüße
 › Lattenrost

De serie
 › marco de la cama fuera del colchón
 › patas de madera
 › somier de lamas

Optional
 › vano contenitore con rete alzabile a doppia apertura
 › doghe ammortizzate
 › piano ortopedico
 › rete amagnetica
 › rete motorizzata
 › giroletto a filo del materasso

Optionals
 › storage compartment with double opening lifttable base
 › sprung slats
 › orthopaedic bed base
 › non-magnetic base
 › electric adjustable base
 › bed frame flush with the mattress

Options
 › coffre avec sommier relevable à double ouverture
 › sommier à lattes amorties
 › plateau orthopédique
 › sommier non magnétique
 › sommier motorisé
 › cadre de lit au ras du matelas

Optionale Ausstattung
 › Bettkasten mit zwei verschiedene Liffunktionen
 › gefederter Lattenrost
 › orthopädische Basis
 › Holzrahmen Lattenrost
 › motorischer Lattenrost
 › Bettrahmen bündig zur Matratze

Opcionales
 › arcón con somier elevable de doble abertura
 › lamas amortiguadas
 › somier ortopédico
 › somier no magnético
 › somier motorizado
 › marco de la cama a ras del colchón

Materasso venduto a parte
 › consulta il catalogo The Art of Sleeping
 www.orizzontiitalia.it

Mattress sold separately
 › see the catalogue The Art of Sleeping
 www.orizzontiitalia.it

Matelas vendu séparément
 › voir le catalogue The Art of Sleeping
 www.orizzontiitalia.it

Matratze separat erhältlich
 › zum Katalog The Art of Sleeping
 www.orizzontiitalia.it

Colchón se vende por separado
 › consultar el catálogo The Art of Sleeping
 www.orizzontiitalia.it

Letto imbottito con rivestimento sfoderabile
 › tessuto
 › ecopelle

Upholstered bed with removable cover
 › fabric
 › faux leather

Lit rembourré avec revêtement amovible
 › tissu
 › similcuir

Gepolstertes Bett mit abnehmbarem Bezug
 › Stoff
 › Kunstleder

Cama tapizada con revestimiento amovible
 › tejido
 › ecopiel

Di serie
 › giroletto esterno al materasso
 › piedi in legno
 › rete a doghe

Standard
 › bed frame outside the mattress
 › wooden feet
 › slatted base

De série
 › cadre de lit à l'extérieur du matelas
 › pieds en bois
 › sommier à lattes

Serienausstattung
 › Bettrahmen außerhalb der Matratze
 › Holzfüße
 › Lattenrost

De serie
 › marco de la cama fuera del colchón
 › patas de madera
 › somier de lamas

Optional
 › vano contenitore con rete alzabile a doppia apertura
 › doghe ammortizzate
 › piano ortopedico
 › rete amagnetica
 › rete motorizzata
 › giroletto a filo del materasso

Optionals
 › storage compartment with double opening lifttable base
 › sprung slats
 › orthopaedic bed base
 › non-magnetic base
 › electric adjustable base
 › bed frame flush with the mattress

Options
 › coffre avec sommier relevable à double ouverture
 › sommier à lattes amorties
 › plateau orthopédique
 › sommier non magnétique
 › sommier motorisé
 › cadre de lit au ras du matelas

Optionale Ausstattung
 › Bettkasten mit zwei verschiedene Liffunktionen
 › gefederter Lattenrost
 › orthopädische Basis
 › Holzrahmen Lattenrost
 › motorischer Lattenrost
 › Bettrahmen ist bündig mit der Matratze

Opcionales
 › arcón con somier elevable de doble abertura
 › lamas amortiguadas
 › somier ortopédico
 › somier no magnético
 › somier motorizado
 › marco de la cama a ras del colchón

Materasso venduto a parte
 › consulta il catalogo The Art of Sleeping
 www.orizzontiitalia.it

Mattress sold separately
 › see the catalogue The Art of Sleeping
 www.orizzontiitalia.it

Matelas vendu séparément
 › voir le catalogue The Art of Sleeping
 www.orizzontiitalia.it

Matratze separat erhältlich
 › zum Katalog The Art of Sleeping
 www.orizzontiitalia.it

Colchón se vende por separado
 › consultar el catálogo The Art of Sleeping
 www.orizzontiitalia.it



Materasso Mattress (cm)	Ingombro Bed size (cm)
160 x 200	175 x 219 x 128H
170 x 200	185 x 219 x 128H
180 x 200	195 x 219 x 128H
200 x 200	215 x 219 x 128H
American Queen Size 60" x 80"	65.7" x 87.4" x 50.4"H
American King Size 76" x 80"	81.9" x 87.4" x 50.4"H

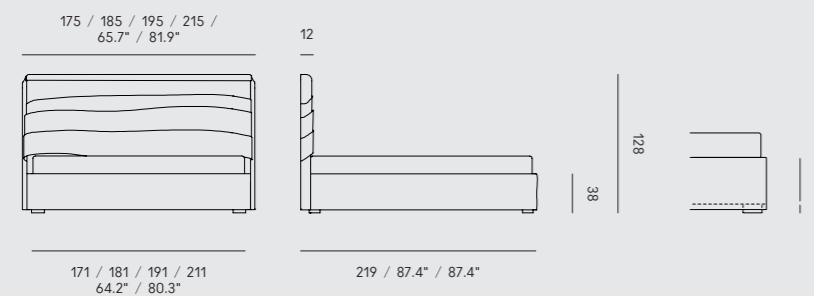

Materasso Mattress (cm)	Ingombro Bed size (cm)
80 x 200	91 x 211 x 38H
90 x 200	101 x 211 x 38H
100 x 200	111 x 211 x 38H
120 x 200	131 x 211 x 38H
140 x 200	151 x 211 x 38H
160 x 200	171 x 211 x 38H
170 x 200	181 x 211 x 38H
180 x 200	191 x 211 x 38H
200 x 200	211 x 211 x 38H
American Queen Size 60" x 80"	64.2" x 84.3" x 15.0"H
American King Size 76" x 80"	80.3" x 84.3" x 15.0"H



Il letto è composto da un sommier con piano ortopedico e da una testiera indipendente da fissare al muro. Entrambi gli elementi sono disponibili in due versioni, liberamente abbinabili tra loro:

- 1) giroletto standard o long
- 2) testiera standard o large

Finitura

> noce canaletto
> rovere naturale

Standard

> piano ortopedico

**Materasso
venduto a parte**

> consulta il catalogo
The Art of Sleeping
www.orizzontiitalia.it

Bed composed of a bed frame and an independent headboard to be fixed to the wall. Both elements are available in two versions, freely combinable with each other:

- 1) standard or long bed frame
- 2) standard or large headboard

Finish

> walnut
> natural oak

Standard

> orthopaedic bed base

**Mattress sold
separately**

> see the catalogue
The Art of Sleeping
www.orizzontiitalia.it

Lit composé d'un cadre et d'une tête de lit indépendante à fixer au mur. Les deux éléments sont disponibles en deux versions, qui peuvent être combinées librement entre elles:

- 1) Cadre de lit standard ou long
- 2) Tête de lit standard ou grande

Finition

> noyer
> chêne naturel

De série

> plateau orthopédique

**Matelas vendu
séparément**

> voir le catalogue
The Art of Sleeping
www.orizzontiitalia.it

Das Bett besteht aus einem Bettrahmen und einem unabhängigen Kopfteil, der an der Wand befestigt werden muss. Beide Elementen können sich frei miteinander kombiniert werden. In zwei Versionen erhältlich:

- 1) Standard oder Long Bettrahmen
- 2) Standard oder Large Kopfteil

Ausführung

> Nussbaum
> Eiche Natur

Serienausstattung

> orthopädische Basis

**Matratze separat
erhältlich**

> zum Katalog
The Art of Sleeping
www.orizzontiitalia.it

Cama compuesta por un marco con somier y un cabecero independiente para fijar a la pared. Ambos elementos están disponibles en dos versiones, libremente combinables entre sí:

- 1) marco de la cama estándar o largo
- 2) cabecero estándar o grande

Acabado

> nogal
> roble natural

De serie

> somier ortopédico

**Colchón
se vende por separado**

> consultar el catálogo
The Art of Sleeping
www.orizzontiitalia.it



Materasso Mattress (cm)	Ingombro letto Bed size (cm)	
160 x 200	Standard	180 x 216 x 27H
	Long	180 x 236 x 27H
180 x 200	Standard	201 x 216 x 27H
	Long	201 x 236 x 27H
American Queen Size 60" x 80"	Standard	67.3" x 86.2" x 10.6"H
	Long	67.3" x 94.1" x 10.6"H
American King Size 76" x 80"	Standard	83.9" x 86.2" x 10.6"H
	Long	83.9" x 94.1" x 10.6"H

mattress 160 / 180

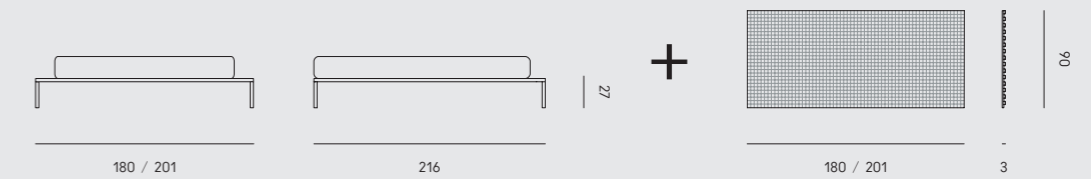
bedframe standard
headboard standard

mattress queen / king

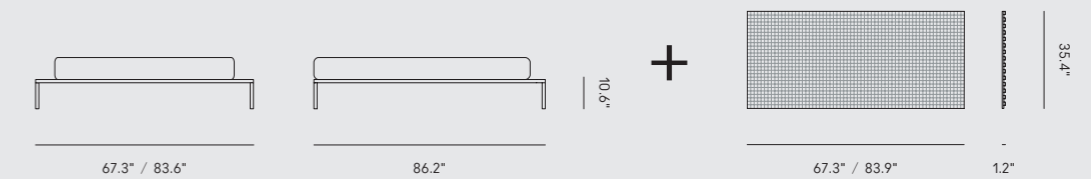
bedframe standard
headboard standard

mattress 160 / 180

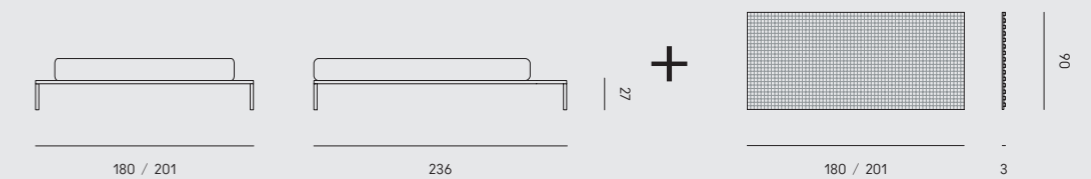
bedframe long
headboard standard

mattress queen / king

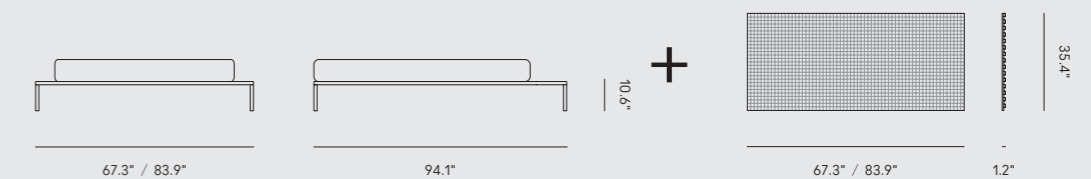
bedframe long
headboard standard

mattress 160 / 180

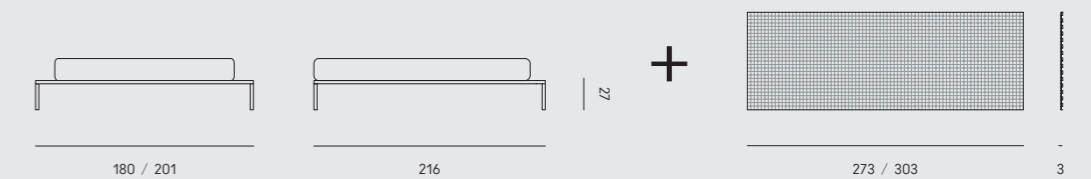
bedframe standard
headboard large

mattress queen / king

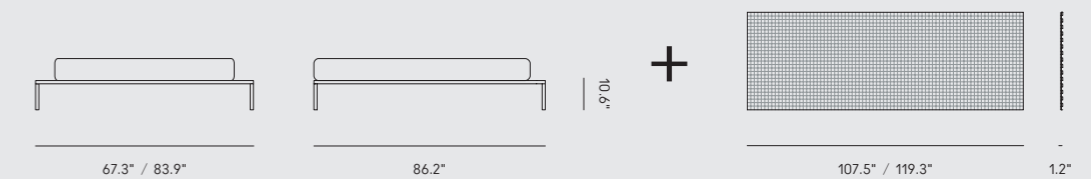
bedframe standard
headboard large

mattress 160 / 180

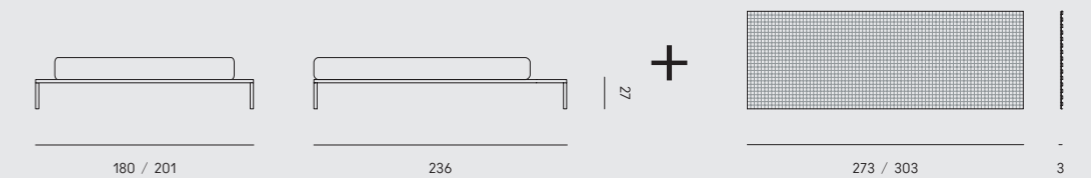
sommier long
headboard large

mattress queen / king

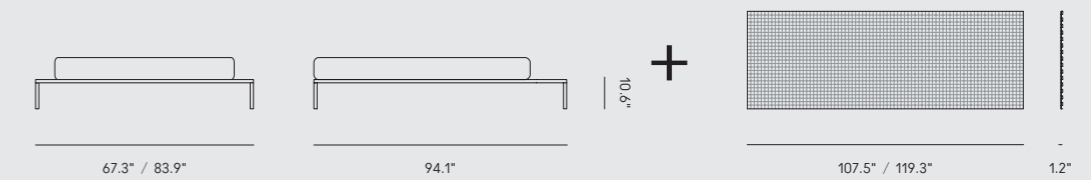
bedframe long
headboard large

Letto imbottito con rivestimento sfoderabile
 › tessuto
 › ecopelle

Upholstered bed with removable cover
 › fabric
 › faux leather

Lit rembourré avec revêtement amovible
 › tissu
 › similcuir

Gepolstertes Bett mit abnehmbarem Bezug
 › Stoff
 › Kunstleder

Cama tapizada con revestimiento amovible
 › tejido
 › ecopiel

Di serie
 › giroletto esterno al materasso
 › piedi in legno
 › rete a doghe

Standard
 › bed frame outside the mattress
 › wooden feet
 › slatted base

De série
 › cadre de lit à l'extérieur du matelas
 › pieds en bois
 › sommier à lattes

Serienausstattung
 › Bettrahmen außerhalb der Matratze
 › Holzfüße
 › Lattenrost

De serie
 › marco de la cama fuera del colchón
 › patas de madera
 › somier de lamas

Optional
 › piedi in alluminio
 › vano contenitore con rete alzabile a doppia apertura
 › doghe ammortizzate
 › piano ortopedico
 › rete amagnetica
 › rete motorizzata
 › giroletto a filo del materasso

Optionals
 › aluminium feet
 › storage compartment with double opening
 › lifttable base
 › sprung slats
 › orthopaedic bed base
 › non-magnetic base
 › electric adjustable base
 › bed frame flush with the mattress

Options
 › pieds en aluminium
 › coffre avec sommier relevable à double ouverture
 › sommier à lattes amorties
 › plateau orthopédique
 › sommier non magnétique
 › sommier motorisé
 › cadre de lit au ras du matelas

Optionale Ausstattung
 › Aluminiumfüße
 › Bettkasten mit zwei verschiedene Liffunktionen
 › gefederter Lattenrost
 › orthopädische Basis
 › Holzrahmen Lattenrost
 › motorischer Lattenrost
 › Bettrahmen bündig zur Matratze

Opcionales
 › patas de aluminio
 › arcón con somier elevable de doble abertura
 › lamas amortiguadas
 › somier ortopédico
 › somier no magnético
 › somier motorizado
 › marco de la cama a ras del colchón

Materasso venduto a parte
 › consulta il catalogo The Art of Sleeping
www.orizzontiitalia.it

Mattress sold separately
 › see the catalogue The Art of Sleeping
www.orizzontiitalia.it

Matelas vendu séparément
 › voir le catalogue The Art of Sleeping
www.orizzontiitalia.it

Matratze separat erhältlich
 › zum Katalog The Art of Sleeping
www.orizzontiitalia.it

Colchón se vende por separado
 › consultar el catálogo The Art of Sleeping
www.orizzontiitalia.it

Letto imbottito con rivestimento sfoderabile
 › tessuto
 › ecopelle

Upholstered bed with removable cover
 › fabric
 › faux leather

Lit rembourré avec revêtement amovible
 › tissu
 › similcuir

Gepolstertes Bett mit abnehmbarem Bezug
 › Stoff
 › Kunstleder

Cama tapizada con revestimiento amovible
 › tejido
 › ecopiel

Di serie
 › giroletto esterno al materasso
 › piedi in legno
 › rete a doghe

Standard
 › bed frame outside the mattress
 › wooden feet
 › slatted base

De série
 › cadre de lit à l'extérieur du matelas
 › pieds en bois
 › sommier à lattes

Serienausstattung
 › Bettrahmen außerhalb der Matratze
 › Holzfüße
 › Lattenrost

De serie
 › marco de la cama fuera del colchón
 › patas de madera
 › somier de lamas

Optional
 › piedi in alluminio
 › vano contenitore con rete alzabile a doppia apertura
 › doghe ammortizzate
 › piano ortopedico
 › rete amagnetica
 › rete motorizzata
 › giroletto a filo del materasso

Optionals
 › aluminium feet
 › storage compartment with double opening
 › lifttable base
 › sprung slats
 › orthopaedic bed base
 › non-magnetic base
 › electric adjustable base
 › bed frame flush with the mattress

Options
 › pieds en aluminium
 › coffre avec sommier relevable à double ouverture
 › sommier à lattes amorties
 › plateau orthopédique
 › sommier non magnétique
 › sommier motorisé
 › cadre de lit au ras du matelas

Optionale Ausstattung
 › Aluminiumfüße
 › Bettkasten mit zwei verschiedene Liffunktionen
 › gefederter Lattenrost
 › orthopädische Basis
 › Holzrahmen Lattenrost
 › motorischer Lattenrost
 › Bettrahmen bündig zur Matratze

Opcionales
 › patas de aluminio
 › arcón con somier elevable de doble abertura
 › lamas amortiguadas
 › somier ortopédico
 › somier no magnético
 › somier motorizado
 › marco de la cama a ras del colchón

Materasso venduto a parte
 › consulta il catalogo The Art of Sleeping
www.orizzontiitalia.it

Mattress sold separately
 › see the catalogue The Art of Sleeping
www.orizzontiitalia.it

Matelas vendu séparément
 › voir le catalogue The Art of Sleeping
www.orizzontiitalia.it

Matratze separat erhältlich
 › zum Katalog The Art of Sleeping
www.orizzontiitalia.it

Colchón se vende por separado
 › consultar el catálogo The Art of Sleeping
www.orizzontiitalia.it



Materasso Mattress (cm)	Ingombro Bed size (cm)
100 x 200	125 x 217 x 106H
160 x 200	185 x 217 x 106H
170 x 200	195 x 217 x 106H
180 x 200	205 x 217 x 106H
200 x 200	225 x 217 x 106H
American Queen Size 60" x 80"	69.7" x 86.6" x 41.7"H
American King Size 76" x 80"	85.8" x 86.6" x 41.7"H

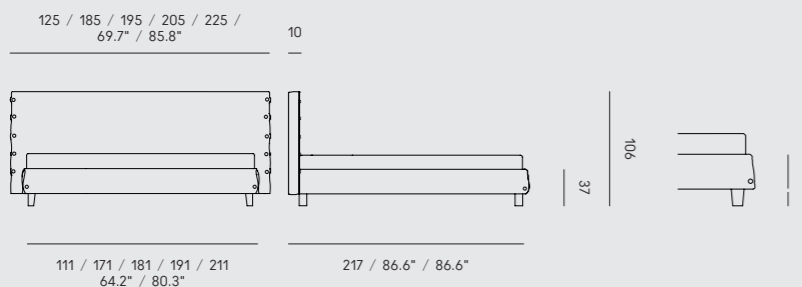

Materasso Mattress (cm)	Ingombro Bed size (cm)
100 x 200	139 x 217 x 144H
160 x 200	199 x 217 x 144H
170 x 200	209 x 217 x 144H
180 x 200	219 x 217 x 144H
200 x 200	239 x 217 x 144H
American Queen Size 60" x 80"	75.2" x 86.6" x 56.7"H
American King Size 76" x 80"	91.3" x 86.6" x 56.7"H

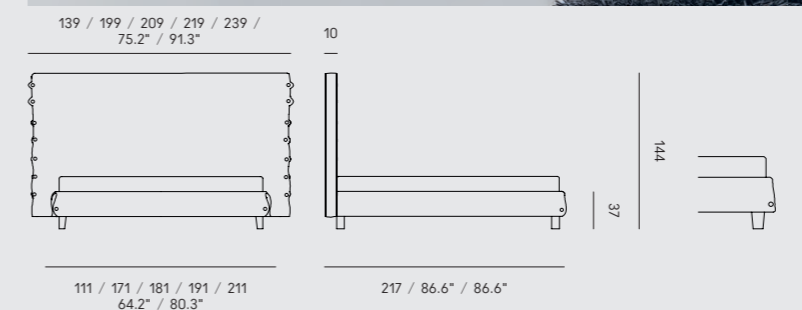

Letto imbottito con rivestimento sfoderabile
 › tessuto
 › ecopelle

Upholstered bed with removable cover
 › fabric
 › faux leather

Lit rembourré avec revêtement amovible
 › tissu
 › similicuir

Gepolstertes Bett mit abnehmbarem Bezug
 › Stoff
 › Kunstleder

Cama tapizada con revestimiento amovible
 › tejido
 › ecopiel

Di serie
 › giroletto esterno al materasso
 › piedi in legno
 › rete a doghe

Standard
 › bed frame outside the mattress
 › wooden feet
 › slatted base

De série
 › cadre de lit à l'extérieur du matelas
 › pieds en bois
 › sommier à lattes

Serienausstattung
 › Bettrahmen außerhalb der Matratze
 › Holzfüße
 › Lattenrost

De serie
 › marco de la cama fuera del colchón
 › patas de madera
 › somier de lamas

Optional
 › piedi in alluminio
 › vano contenitore con rete alzabile a doppia apertura
 › doghe ammortizzate
 › piano ortopedico
 › rete amagnetica
 › rete motorizzata
 › giroletto a filo del materasso

Optionals
 › aluminium feet
 › storage compartment with double opening
 › sprung slats
 › orthopaedic bed base
 › non-magnetic base
 › electric adjustable base
 › bed frame flush with the mattress

Options
 › pieds en aluminium
 › coffre avec sommier relevable à double ouverture
 › sommier à lattes amorties
 › plateau orthopédique
 › sommier non magnétique
 › sommier motorisé
 › cadre de lit au ras du matelas

Optionale Ausstattung
 › Aluminiumfüße
 › Bettkasten mit zwei verschiedene Liffunktionen
 › gefederter Lattenrost
 › orthopädische Basis
 › Holzrahmen Lattenrost
 › motorischer Lattenrost
 › Bettrahmen bündig zur Matratze

Opcionales
 › patas de aluminio
 › arcón con somier elevable de doble abertura
 › lamas amortiguadas
 › somier ortopédico
 › somier no magnético
 › somier motorizado
 › marco de la cama a ras del colchón

Materasso venduto a parte
 › consulta il catalogo The Art of Sleeping
 www.orizzontiitalia.it

Mattress sold separately
 › see the catalogue The Art of Sleeping
 www.orizzontiitalia.it

Matelas vendu séparément
 › voir le catalogue The Art of Sleeping
 www.orizzontiitalia.it

Matratze separat erhältlich
 › zum Katalog The Art of Sleeping
 www.orizzontiitalia.it

Colchón se vende por separado
 › consultar el catálogo The Art of Sleeping
 www.orizzontiitalia.it

Testiera imbottita da fissare al muro con rivestimento sfoderabile
 › tessuto
 › pelle
 › ecopelle

Upholstered wall-mounted headboard with removable cover
 › fabric
 › leather
 › faux-leather

Tête de lit rembourrée à fixer au mur avec revêtement amovible
 › tissu
 › cuir
 › similicuir

Gepolsterter Kopfteil zur Befestigung an der Wand mit abnehmbarem Bezug
 › Stoff
 › Leder
 › Kunstleder

Cabecero tapizado con fijación a la pared con revestimiento amovible
 › tejido
 › piel
 › ecopiel

Dimensioni
 › testiera High cm 210 x 170H
 › testiera Large cm 300 x 120H
 › al centimetro, su misura cliente

Dimensions
 › High headboard cm 210 x 170H
 › Large headboard cm 300 x 120H
 › made-to-measure, upon customer's request

Mesures
 › tête de lit High cm 210 x 170H
 › tête de lit Large cm 300 x 120H
 › au centimètre, sur mesure conformément aux desiderata du client.

Größe
 › Kopfteil High cm 210 x 170H
 › Kopfteil Large cm 300 x 120H
 › Nach Kundenwunsch, Kopfteil auf den cm genau hergestellt

Dimensiones
 › cabecero High cm 210 x 170H
 › cabecero Large cm 300 x 120H
 › al centimetro, bajo medida del cliente

Varianti
 › rivestimento liscio
 › rivestimento trapuntato

Variants
 › plain cover
 › quilted cover

Variantes
 › revêtement lisse
 › revêtement matelassé

Varianten
 › glatter Bezug
 › gesteppter Bezug

Variantes
 › revestimiento liso
 › revestimiento acolchado



Materasso Mattress (cm)	Ingombro Bed size (cm)
80 x 200	91 x 211 x 37H
90 x 200	101 x 211 x 37H
100 x 200	111 x 211 x 37H
120 x 200	131 x 211 x 37H
140 x 200	151 x 211 x 37H
160 x 200	171 x 211 x 37H
170 x 200	181 x 211 x 37H
180 x 200	191 x 211 x 37H
200 x 200	211 x 211 x 37H
American Queen Size 60" x 80"	64.2" x 84.3" x 14.6"H
American King Size 76" x 80"	80.3" x 84.3" x 14.6"H



Testiera High
High Headboard
Tête de lit High
Kopfteil High
Cabecero High

cm 210 x 10 x 170H
82.7" x 3.9" x 66.9"H



Testiera Large
Large Headboard
Tête de lit Large
Kopfteil Large
Cabecero Large

cm 300 x 10 x 120H
118.1" x 3.9.3" x 47.2"H

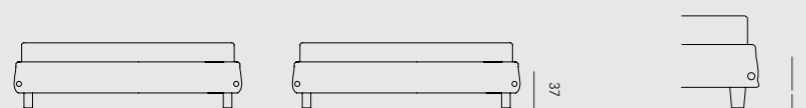

91 / 101 / 111 / 131 / 151 / 171 /
181 / 191 / 211 / 64.2" / 80.3"

211 / 84.3" / 84.3"

37

25
12

Divani letto / Schede tecniche

Sofa beds / Technical sheets

Canapés-lits / Fiches techniques

Bettsofas / Technische Datenblätter

Sofás cama / Fichas técnicas

Modalità d'uso

- > divano
- > 2 letti singoli
misura materasso
cm 80 x 200 x 12H
- > letto matrimoniale
misura materasso
cm 160 x 200 x 12H

How to use it

- > sofa
- > 2 single bed
mattress size
cm 80 x 200 x 12H
- > one double bed
mattress size
cm 160 x 200 x 12H

Modes d'utilisation

- > canapé
- > 2 lits simples
mesure des matelas
cm 80 x 200 x 12H
- > lit double
mesure matelas
cm 160 x 200 x 12H

Verwendungsarten

- > Couch
- > 2 Einzelbetten
Matratzengröße
cm 80 x 200 x 12H
- > Doppelbett
Matratzengröße
cm 160 x 200 x 12H

Modalidades de uso

- > sillón
- > 2 camas individuales
tamaño del colchón
cm 80 x 200 x 12H
- > cama doble
tamaño del colchón
cm 160 x 200 x 12H

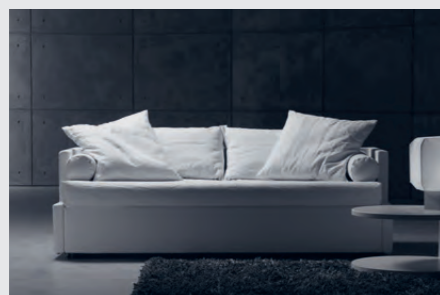
Caratteristiche

- > rivestimento sfoderabile in tessuto o ecopelle
- > [1] piano ortopedico
- > [2] maniglie di cuoio per l'aggancio dei letti singoli
- > [3] coprimaterasso imbottito

Features

- > removable cover in fabric or faux-leather
- > [1] orthopaedic base
- > [2] leather handles for connecting the single beds
- > [3] padded bedspread

Caractéristiques

- > revêtement amovible en tissu ou similcuir
- > [1] sommier en bois
- > [2] poignées en cuir pour fixer les lits simples
- > [3] couvre-lit rembourré

Eigenschaften

- > abnehmbar Stoff- oder Kunstlederbezug
- > [1] orthopädische Basis
- > [2] Ledergriffe zur Befestigung der Einzelbetten
- > [3] gepolsterte Tagesdecke

Características

- > revestimiento amovible en tejido o ecopiel
- > [1] somier ortopédico
- > [2] asas de cuero para unir las camas individuales
- > [3] cobertor acolchado

Materassi

A scelta del cliente i materassi possono essere:

- > Sit & Sleep Standard materasso in schiuma ecologica con fodera di rivestimento semplice in misto cotone.
- > Sit & Sleep Memory materasso composto da una lastra in schiuma ecologica accoppiata a una lastra di schiuma viscoelastica a memoria di forma. Fodera in misto cotone trapuntata e imbottita con fibra anallergica.

Mattresses

At the customer's choice the mattresses can be:

- > Sit & Sleep Standard ecological foam mattress with a simple cotton blend lining.
- > Sit & Sleep Memory mattress consists of an ecological foam plate coupled with a sheet of viscoelastic memory foam. Quilted cover in mixed cotton, padded with hypoallergenic fibre.

Matelas

Au choix du client, les matelas peuvent être:

- > Sit & Sleep Standard matelas en mousse écologique avec doublure simple en coton mélangé.
- > Sit & Sleep Memory matelas composé d'une feuille de mousse écologique couplée à une feuille de mousse à mémoire viscoélastique. Doublure en coton mélangé matelassé et rembourré avec des fibres hypoallergéniques.

Matratzen

Die Matratzen können nach Wahl des Kunden sein:

- > Sit & Sleep Standard Ökologische Schaumstoffmatratze mit einfachem Überzug aus Baumwollmischung.
- > Sit & Sleep Memory Matratze aus einer ökologischen Schaumstoffplatte in Verbund mit einer aus Memory- und viskoelastischen Schaumstoffplatte. Ein gesteppter und mit antiallergischen Fasern gefüllten Überzug aus Baumwollgemisch.

Colchones

Los colchones pueden ser a elección del cliente:

- > Sit & Sleep Standard colchón de espuma ecológica con forro de mezcla de algodón simple.
- > Sit & Sleep Memory colchón compuesto por una lámina de espuma ecológica unida a una lámina de espuma viscoelástica con memoria de forma. Forro de mezcla de algodón, relleno y acolchado con fibra hipoalergénica.

Accessori opzionali

- > cuscini, guanciali e rulli

Optional accessories

- > cushions, pillows and bolsters

Accessoires en option

- > coussins, oreillers et traversins

Optionale Zubehör

- > Kissen, Kopfkissen und Kissenrollen

Accesorios opcionales

- > cojines, almohadas y cojines cilíndricos

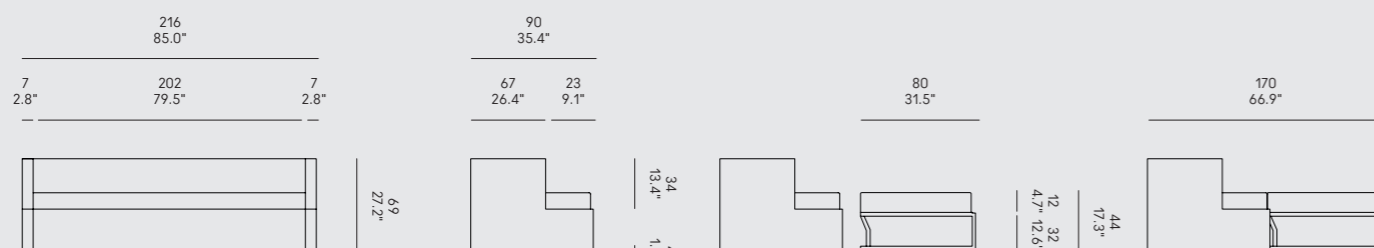

Modalità d'uso

- > divano
- > 2 letti singoli
misura materasso
cm 90 x 200 x 16H
cm 85 x 200 x 16H
- > letto matrimoniale
misura materasso
cm 175 x 200 x 16H

How to use it

- > sofa
- > 2 single bed
mattress size
cm 90 x 200 x 16H
cm 85 x 200 x 16H
- > one double bed
mattress size
cm 175 x 200 x 16H

Modes d'utilisation

- > canapé
- > 2 lits simples
mesure des matelas
cm 90 x 200 x 16H
cm 85 x 200 x 16H
- > lit double
mesure matelas
cm 175 x 200 x 16H

Verwendungsarten

- > Couch
- > 2 Einzelbetten
Matratzengröße
cm 90 x 200 x 16H
cm 85 x 200 x 16H
- > Doppelbett
Matratzengröße
cm 175 x 200 x 16H

Modalidades de uso

- > sillón
- > 2 camas individuales
tamaño del colchón
cm 90 x 200 x 16H
cm 85 x 200 x 16H
- > cama doble
tamaño del colchón
cm 175 x 200 x 16H



isola	218 85.8"	103 40.6"	85 33.5"	188 74.0"
isolino	221 87.0"	103 40.6"	85 33.5"	188 74.0"
isolina	221 87.0"	107 42.1"	85 33.5"	192 75.6"
isoleuse	224 88.2"	103 40.6"	85 33.5"	188 74.0"
isoletto	218 85.8"	107 42.1"	85 33.5"	192 75.6"
isolotto	224 88.2"	107 42.1"	85 33.5"	192 75.6"

Caratteristiche

- > rivestimento sfoderabile in tessuto o ecopelle
- > [1] piano ortopedico
- > [2] maniglie di cuoio per l'aggancio dei letti singoli
- > [3] coprimaterasso imbottito

Features

- > removable cover in fabric or faux-leather
- > [1] orthopaedic base
- > [2] leather handles for connecting the single beds
- > [3] padded bedspread

Caractéristiques

- > revêtement amovible en tissu ou similcuir
- > [1] sommier en bois
- > [2] poignées en cuir pour fixer les lits simples
- > [3] couvre-lit rembourré

Eigenschaften

- > abnehmbar Stoff- oder Kunstlederbezug
- > [1] orthopädische Basis
- > [2] Ledergriffe zur Befestigung der Einzelbetten
- > [3] gepolsterte Tagesdecke

Características

- > revestimiento amovible en tejido o ecopiel
- > [1] somier ortopédico
- > [2] asas de cuero para unir las camas individuales
- > [3] cobertor acolchado

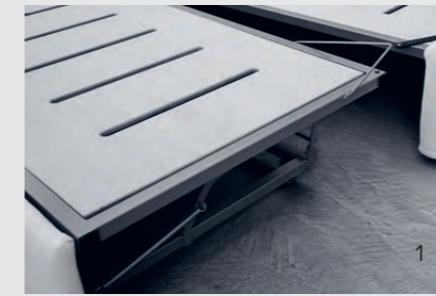
Materassi

A scelta del cliente i materassi possono essere:

- > **Sit & Sleep Standard** materasso in schiuma ecologica con fodera di rivestimento semplice in misto cotone.
- > **Sit & Sleep Memory** materasso composto da una lastra in schiuma ecologica accoppiata a una lastra di schiuma viscoelastica a memoria di forma. Fodera in misto cotone trapuntata e imbottita con fibra anallergica.

Mattresses

At the customer's choice the mattresses can be:

- > **Sit & Sleep Standard** ecological foam mattress with a simple cotton blend lining.
- > **Sit & Sleep Memory** mattress consists of an ecological foam plate coupled with a sheet of viscoelastic memory foam. Quilted cover in mixed cotton, padded with hypoallergenic fibre.

Matelas

Au choix du client, les matelas peuvent être:

- > **Sit & Sleep Standard** matelas en mousse écologique avec doublure simple en coton mélangé.
- > **Sit & Sleep Memory** matelas composé d'une feuille de mousse écologique couplée à une feuille de mousse à mémoire viscoélastique. Doublure en coton mélangé matelassé et rembourré avec des fibres hypoallergéniques.

Matratzen

Der Kunde kann zwischen die folgenden Matratzen wählen:

- > **Sit & Sleep Standard** Ökologische Schaumstoffmatratze mit einfachem Überzug aus Baumwollmischung.
- > **Sit & Sleep Memory** Matratze aus einer ökologischen Schaumstoffplatte in Verbund mit einer aus Memory- und viskoelastischen Schaumstoffplatte. Ein gesteppter und mit antiallergischen Fasern gefüllten Überzug aus Baumwollgemisch.

Colchones

Los colchones pueden ser a elección del cliente:

- > **Sit & Sleep Standard** colchón de espuma ecológica con forro de mezcla de algodón simple.
- > **Sit & Sleep Memory** colchón compuesto por una lámina de espuma ecológica unida a una lámina de espuma viscoelástica con memoria de forma. Forro de mezcla de algodón, relleno y acolchado con fibra hipoalergénica.

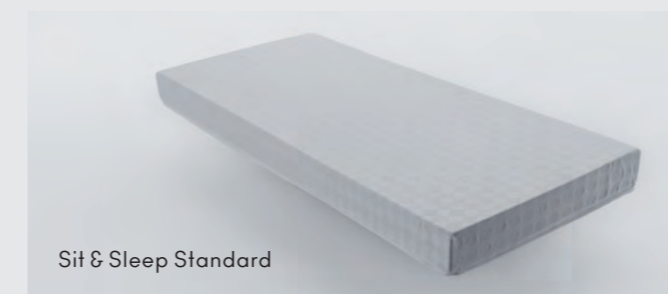

Sit & Sleep Standard

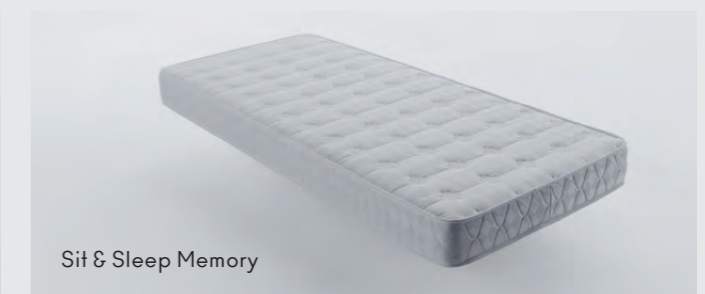

Sit & Sleep Memory

Accessori opzionali

- > cuscini, guanciali e rulli

Optional accessories

- > cushions, pillows and bolsters

Accessoires en option

- > coussins, oreillers et traversins

Optionale Zubehör

- > Kissen, Kopfkissen und Kissenrollen

Accesorios opcionales

- > cojines, almohadas y cojines cilíndricos

Modalità d'uso	How to use it	Modes d'utilisation	Verwendungsarten	Modalidades de uso
<ul style="list-style-type: none"> > divano > letto matrimoniale misura materasso cm 160 x 200 x 12H 	<ul style="list-style-type: none"> > sofa > one double bed mattress size cm 160 x 200 x 12H 	<ul style="list-style-type: none"> > canapé > lit double mesure matelas cm 160 x 200 x 12H 	<ul style="list-style-type: none"> > Couch > Doppelbett Matratzengröße cm 160 x 200 x 12H 	<ul style="list-style-type: none"> > sillón > cama doble tamaño del colchón cm 160 x 200 x 12H

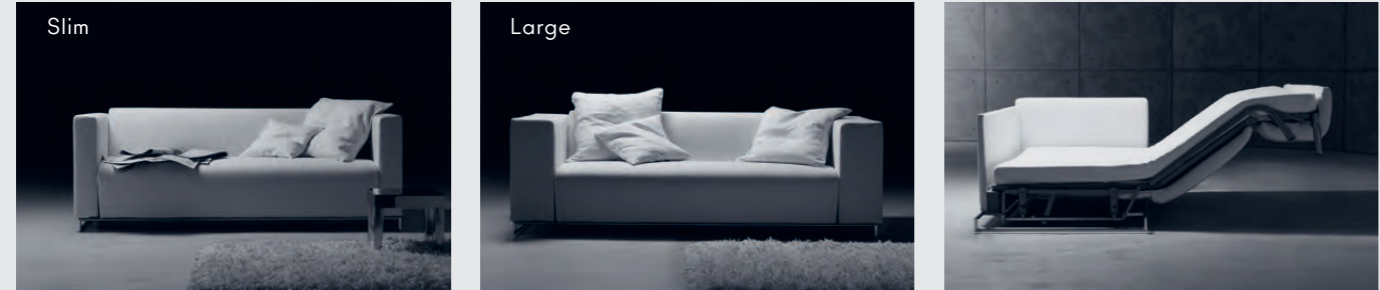

Caratteristiche	Features	Caractéristiques	Eigenschaften	Características
<ul style="list-style-type: none"> > rivestimento sfoderabile in tessuto o ecopelle > rete in metallo elettrosaldata > materasso in schiuma ecologica con fodera di rivestimento in misto cotone trapuntata e imbottita con fibra anallergica 	<ul style="list-style-type: none"> > removable cover in fabric or faux-leather > bed base made of electrowelded mesh > ecological foam mattress with quilted cotton blend lining, padded with hypoallergenic fibre 	<ul style="list-style-type: none"> > revêtement amovible en tissu ou similcuir > sommier à maille électrosoudée > matelas en mousse écologique avec doublure en coton mélangé matelassé et rembourré avec des fibres hypoallergéniques. 	<ul style="list-style-type: none"> > abnehmbar Stoff- oder Kunstleder bezug > elektrogeschweißter Lattenrost > ökologische Schaumstoffmatratze mit gestepptem und mit antiallergischen Fasern gefüllten Überzug aus Baumwollmischung. 	<ul style="list-style-type: none"> > revestimiento amovible in tejido o ecopiel > somier metálico de malla electrosoldada > colchón de espuma ecológica con forro de mezcla de algodón acolchado y con fibra hipoalergénica

Varianti	Variants	Variantes	Varianten	Variantes
<ul style="list-style-type: none"> > Slim (Largh. 196 cm) > Large (Largh. 220 cm) 	<ul style="list-style-type: none"> > Slim (Width 196 cm) > Large (Width 220 cm) 	<ul style="list-style-type: none"> > Slim (Largeur 196 cm) > Large (Largeur 220 cm) 	<ul style="list-style-type: none"> > Slim (Breite 196 cm) > Large (Breite 220 cm) 	<ul style="list-style-type: none"> > Slim (Ancho 196 cm) > Large (Ancho 220 cm)

Accessori opzionali	Optional accessories	Accessoires en option	Optionale Zubehöre	Accesorios opcionales
<ul style="list-style-type: none"> > cuscini, guanciali e rulli 	<ul style="list-style-type: none"> > cushions, pillows and bolsters 	<ul style="list-style-type: none"> > coussins, oreillers et traversins 	<ul style="list-style-type: none"> > Kissen, Kopfkissen und Kissenrollen 	<ul style="list-style-type: none"> > cojines, almohadas y cojines cilíndricos

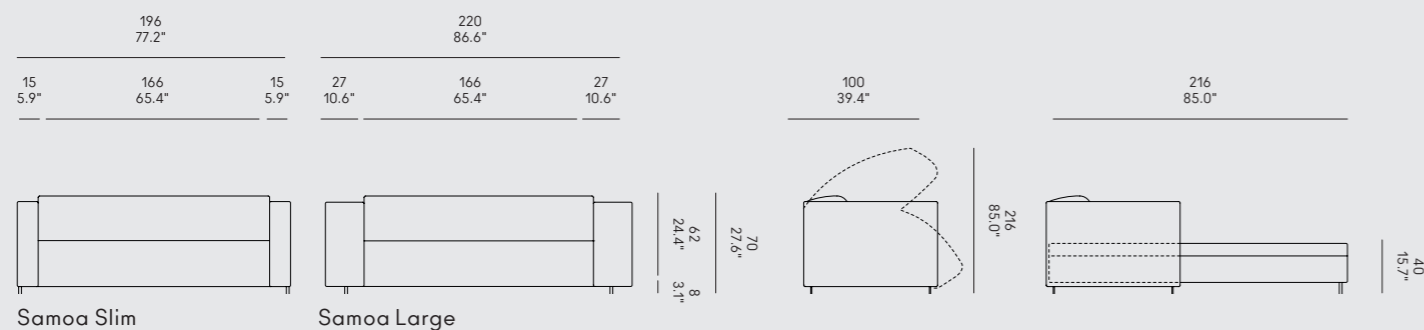

Modalità d'uso	How to use it	Modes d'utilisation	Verwendungsarten	Modalidades de uso
<ul style="list-style-type: none"> > divano > 2 letti singoli misura materasso cm 80 x 200 x 16H > letto matrimoniale misura materasso cm 160 x 200 x 16H 	<ul style="list-style-type: none"> > sofa > 2 single bed mattress size cm 80 x 200 x 16H > one double bed mattress size cm 160 x 200 x 16H 	<ul style="list-style-type: none"> > canapé > 2 lits simples mesure des matelas cm 80 x 200 x 16H > lit double mesure matelas cm 160 x 200 x 16H 	<ul style="list-style-type: none"> > Couch > 2 Einzelbetten Matratzengröße cm 80 x 200 x 16H > Doppelbett Matratzengröße cm 160 x 200 x 16H 	<ul style="list-style-type: none"> > sillón > 2 camas individuales tamaño del colchón cm 80 x 200 x 16H > cama doble tamaño del colchón cm 160 x 200 x 16H



Caratteristiche	Features	Caractéristiques	Eigenschaften	Características
<ul style="list-style-type: none"> > rivestimento sfoderabile in tessuto o ecopelle > piano ortopedico > materasso in schiuma ecologica 	<ul style="list-style-type: none"> > removable cover in fabric or faux-leather > orthopaedic bed base > ecological foam mattress 	<ul style="list-style-type: none"> > revêtement amovible en tissu ou similcuir > sommier en bois > matelas en mousse écologique 	<ul style="list-style-type: none"> > abnehmbar Stoff- oder Kunstleder bezug > orthopädische Basis > ökologische Schaumstoffmatratze 	<ul style="list-style-type: none"> > revestimiento amovible in tejido o ecopiel > somier ortopédico > colchón de espuma ecológica

Accessori opzionali	Optional accessories	Accessoires en option	Optionale Zubehöre	Accesorios opcionales
<ul style="list-style-type: none"> > [1] contenitore > [2] cuscini, guanciali e rulli 	<ul style="list-style-type: none"> > [1] storage > [2] cushions, pillows and bolsters 	<ul style="list-style-type: none"> > [1] coffre > [2] coussins, oreillers et traversins 	<ul style="list-style-type: none"> > [1] Bettkasten > [2] Kissen, Kopfkissen und Kissenrollen 	<ul style="list-style-type: none"> > [1] arcón > [2] cojines, almohadas y cojines cilíndricos

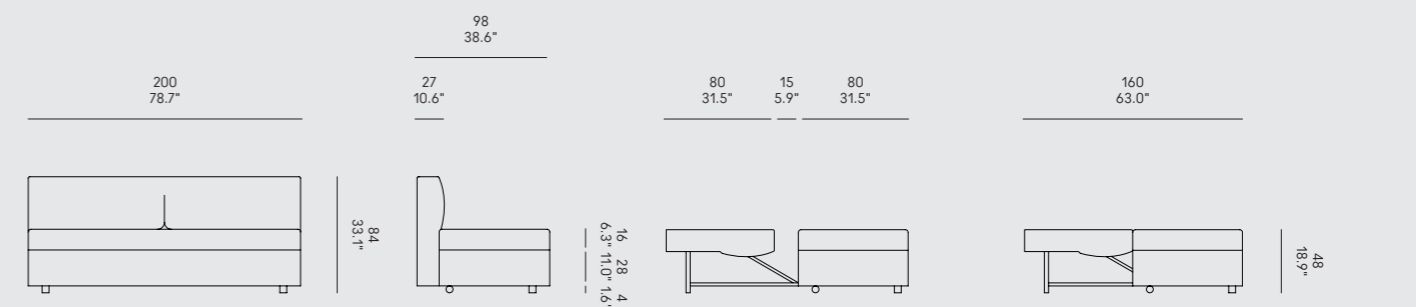
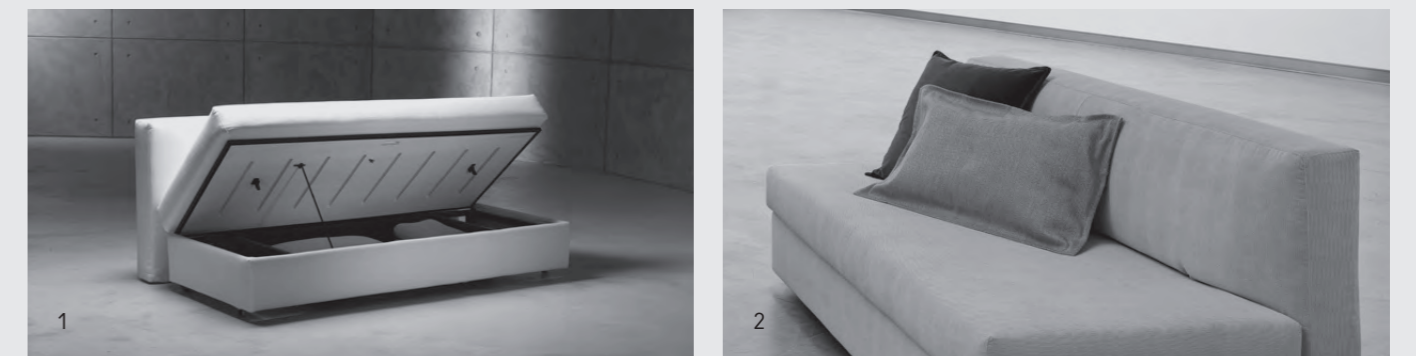

Isole Figi / Schede tecniche

Fiji Islands / Technical sheets

Îles Figi / Fiches techniques

Fiji-Inseln / Technische Datenblätter

Islas Figi / Fichas técnicas

Il programma Isole Figi offre 270 combinazioni di divani letto diverse tra loro.





The Figi Islands program offers 270 different combinations of sofa beds.



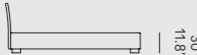
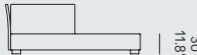
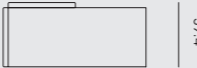
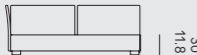
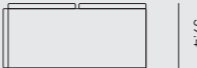
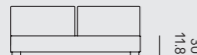
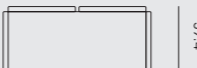
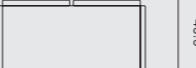

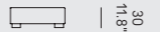

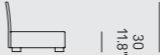
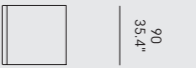
Le programme des Îles Figi offre 270 combinaisons différentes de canapés-lits.

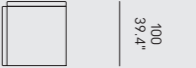
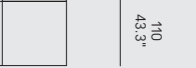
Das Angebot der Figi-Inseln bietet 270 verschiedene Schlafcouch Kombinationen

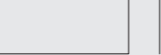
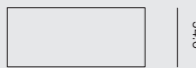
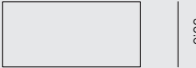
El programa de las Islas Figi ofrece 270 combinaciones diferentes de sofás-cama.

	Figi Compact	Figi 88	Figi 98
isola	 197 77.6" 30 11.8" 82 32.3"	 210 82.6" 90 35.4"	 210 82.6" 100 39.4"
isolino	 207 81.5" 30 11.8" 77 30.3"	 220 86.6" 90 35.4"	 220 86.6" 100 39.4"
isolina	 207 81.5" 30 11.8" 77 30.3"	 220 86.6" 100 39.4"	 220 86.6" 110 43.3"
isolona	 207 81.5" 30 11.8" 77 30.3"	 220 86.6" 100 39.4"	 220 86.6" 110 43.3"
isoletto	 197 77.6" 30 11.8" 77 30.3"	 210 82.6" 100 39.4"	 210 82.6" 110 43.3"
isoleuse	 217 85.4" 30 11.8" 77 30.3"	 230 90.5" 90 35.4"	 230 90.5" 100 39.4"
isolotto	 217 85.4" 30 11.8" 77 30.3"	 230 90.5" 100 39.4"	 230 90.5" 110 43.3"

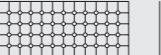
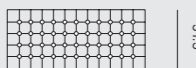
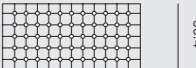
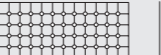
	Figi Compact	Figi 88	Figi 98
mezza isola	 82 32.3" 30 11.8"	 90 35.4"	 100 39.4"
mezzo isolino	 92 36.2" 77 30.3" 30 11.8"	 100 39.4"	 110 43.3"
mezza isolona	 92 36.2" 77 30.3" 30 11.8"	 100 39.4"	 110 43.3"

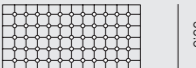
	Figi Compact	Figi 88	Figi 98
seduta senza bottoni seat without buttons assise sans boutons Sitz ohne Knöpfe asiento sin botones	 197 77.6" 82 32.3"	 208 81.9" 88 34.6"	 208 81.9" 98 38.6"
seduta con bottoni seat with buttons assise avec boutons Sitz mit Knöpfe asiento con botones	 197 77.6" 82 32.3"	 208 81.9" 88 34.6"	 208 81.9" 98 38.6"
materasso mattress matelas Matratze colchón	 195 76.8" 80 31.5"	 200 78.7" 80 31.5"	 200 78.7" 90 35.4"
materasso per rete estraibile mattress for pull-out bed matelas pour lit gigogne Matratze für ausziehbares Bett colchón para cama extraible	 180 70.9" 70 27.6"	 190 74.8" 75 29.5"	 190 74.8" 85 33.5"

Le isole Figi sono disponibili in tre Modelli:

- > [1] fisso
- > [2] caveau
- > [3] estraibile

The Figi Islands are available in three Models:

- > [1] fixed
- > [2] storage
- > [3] pull-out

Les îles Figi sont disponibles en trois Modèles:

- > [1] fixe
- > [2] coffre
- > [3] gigogne

Die Figi-Inseln sind in drei Modellen erhältlich:

- > [1] Fest
- > [2] Aufklappbar
- > [3] Ausziehbar

Las Islas Figi están disponibles en tres Modelos:

- > [1] fijo
- > [2] canapé
- > [3] extraíble

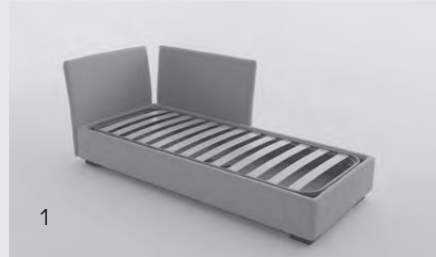

1

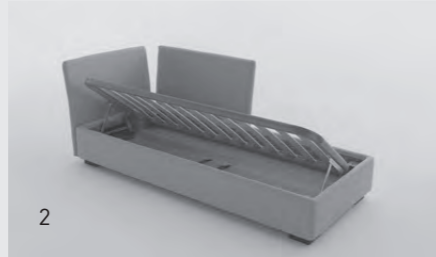

2



3

Configurazione standard

Il prodotto include i seguenti elementi:

- > per [1-2-3]: struttura
- > per [1-2-3]: rete a doghe
- > per [1-2-3]: rivestimento sfoderabile in tessuto, pelle o ecopelle
- > per [2]: contenitore con rete alzabile
- > per [3]: rete estraibile in legno

Alla configurazione standard è necessario aggiungere gli elementi di completamento secondo le esigenze del cliente.

Elementi di completamento

- > [4] cuscino di seduta senza bottoni - sfoderabile
- > [5] cuscino di seduta con bottoni - non sfoderabile
- > [6] materasso modello Sit & Sleep
- > altri materassi della collezione www.orizzontiitalia.it

Standard configuration

The product includes the following elements:

- > for [1-2-3]: structure
- > for [1-2-3]: slatted base
- > for [1-2-3]: removable cover in fabric, leather or faux leather
- > for [2]: liftable base with storage
- > for [3]: pull-out wooden base

In addition to the standard configuration shown below, the elements of completion must be added as required by the customer.

Elements of completion

- > [4] cushion seat without buttons - removable cover
- > [5] cushion seat with buttons - non removable cover
- > [6] mattress, model Sit & Sleep
- > any other mattress of the collection www.orizzontiitalia.it

Configuration standard

Le produit comprend les éléments suivants:

- > pour [1-2-3]: structure
- > pour [1-2-3]: sommier à lattes
- > pour [1-2-3]: housse amovible en tissu, cuir ou similicuir
- > pour [2]: coffre avec sommier relevable
- > pour [3]: sommier extractible en bois

À la configuration standard est nécessaire d'ajouter les éléments de finition selon les besoins du client.

Éléments de finition

- > [4] coussin d'assise sans boutons - déhoussable
- > [5] coussin d'assise avec des boutons - pas déhoussable
- > [6] modèle de matelas Sit & Sleep
- > tout autre matelas de la collection www-orizzontiitalia.it

Serienausstattung

Das Produkt beinhaltet die folgenden Elemente:

- > für [1-2-3]: Struktur
- > für [1-2-3]: Lattenrost
- > für [1-2-3]: Stoff, Kunstleder- oder Leder bezug
- > für [2]: Bettkasten mit Stauraum
- > für [3]: Ausziehbarer Holzlattenrost

In der Serienausstattung ist es notwendig, die Ergänzungselemente nach die Bedürfnissen den Kunden hinzuzufügen.

Ergänzungselemente

- > [4] Sitz ohne Knöpfe - abnehmbar Bezug
- > [5] Sitz mit Knöpfe - nichtabnehmbar Bezug
- > [6] Matratze Sit & Sleep
- > eine Matratze von der Kollektion www.orizzontiitalia.it

Configuración de serie

El producto incluye los siguientes elementos:

- > para [1-2-3]: estructura
- > para [1-2-3]: somier de lamas
- > para [1-2-3]: funda amovible de tela, piel o ecopiel
- > para [2]: arcón con red elevable
- > para [3]: red de madera extraíble

A la configuración de serie hay que añadir los elementos complementarios según las necesidades del cliente.

Elementos complementarios

- > [4] cojín de asiento sin botones - desenfundable
- > [5] cojín de asiento con botones - no es desenfundable
- > [6] modelo de colchón Sit & Sleep
- > cualquier otro colchón de la colección www.orizzontiitalia.it



4



5



6

Materassi Sit & Sleep

- > **Standard**
materasso in schiuma ecologica con fodera di rivestimento semplice in misto cotone.
- > **Memory**
materasso composto da una lastra in schiuma ecologica accoppiata a una lastra di schiuma viscoelastica a memoria di forma. Fodera in misto cotone trapuntata e imbottita con fibra anallergica.

Sit & Sleep mattresses

- > **Standard**
ecological foam mattress with simple cotton blend lining.
- > **Memory**
mattress consists of an ecological foam plate coupled with a sheet of viscoelastic memory foam. Quilted cover in mixed cotton, padded with hypoallergenic fibre.

Matelas Sit & Sleep

- > **Standard**
matelas en mousse écologique avec doublure simple en coton mélangé.
- > **Memory**
matelas composé d'une feuille de mousse écologique couplée à une feuille de mousse à mémoire viscoélastique. Housse de coussin en coton mélangé matelassé et rembourré des fibres hypoallergéniques.

Sit & Sleep Matratzen

- > **Standard**
Ökologische Schaumstoffmatratze mit einfachem Überzug aus Baumwollmischung.
- > **Memory**
Matratze aus einer ökologischen Schaumstoffplatte in Verbund mit einer aus Memory- und viskoelastischen Schaumstoffplatte. Ein gesteppter und mit antiallergischen Fasern gefüllten Überzug aus Baumwollgemisch.

Colchones Sit & Sleep

- > **Standard**
colchón de espuma ecológica con forro de mezcla de algodón simple.
- > **Memory**
colchón compuesto por una lámina de espuma ecológica unida a una lámina de espuma viscoelástica con memoria de la forma. Forro de algodón acolchado con fibra hipoalergénica.

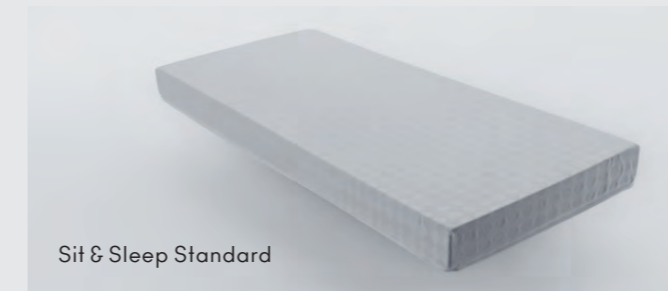

Sit & Sleep Standard



Sit & Sleep Memory

Accessori opzionali

- > [7] copriletto leggermente imbottito
- > [8] cuscino imbottito per schienale
- > [9] cuscini, guanciali e rulli

Optional accessories

- > [7] lightly-padded bedspread
- > [8] padded cushion for backrest
- > [9] cushions, pillows and bolsters

Accessoires en option

- > [7] couvre-lit légèrement rembourré
- > [8] coussin rembourré pour dossier
- > [9] coussins, oreillers et traversins

Optionale Zubehöre

- > [7] gepolsterte Tagesdecke
- > [8] Polsterkissen für Rückenlehne
- > [9] Kissen, Kopfkissen und Kissenrollen

Accesorios opcionales

- > [7] cobertor ligeramente acolchada
- > [8] cojín relleno para el respaldo
- > [9] cojines, almohadas y cojines cilíndricos



7



8



9



10

Art Director

Renato Zamberlan

Photos

Gianni Antoniali
/ Ikon Productions

except:

Orizzonti image bank
58, 59, 60, 76, 77,
88, 106

Set Dresser

Claudia Sani
/ Ikon Productions

Thanks to:

Bosa Ceramiche
Cc-tapis
London Art
PArCo, Galleria
d'Arte Moderna e
Contemporanea
"A.Pizzinato"

Horm, Casamania and Orizzonti Italia
are registered trademarks of:

Horm Italia Srl

via Antonio Carpenè, 17
33070 Brugnera (PN)
Italy

International
Sales Desk
orders@horm.it
Tel. +39 0434 1979101

Ufficio Commerciale
Italia
ordini@horm.it
Tel. +39 0434 1979102

horm.it
casamania.it
orizzontiitalia.it

#HormDesign
#Casamania
#HormCasamania

© Horm Italia Srl



Tutti i prodotti illustrati
in questo catalogo sono
Made in Italy

All products illustrated
in this catalogue are
Made in Italy

Tous les produits
illustrés dans
ce catalogue sont
Made in Italy

Alle produkte in
diesem katalog sind
Made in Italy

Todos los productos
presentados en este
catálogo son
Made in Italy

Horm Italia Srl si riserva
la facoltà di apportare,
in qualunque momento
e senza preavviso,
modifiche e/o migliorie
di carattere tecnico
o estetico ai prodotti
illustrati nel presente
catalogo e declina
ogni responsabilità per
eventuali inesattezze
contenute nello stesso.
Le textures ed i colori
dei materiali e delle
finiture hanno valore
indicativo in quanto
soggetti alle tolleranze
dei processi di stampa.

Horm Italia Srl reserves
the right to make, at
any time and without
notice, technical or
aesthetic changes
and/or improvements to
the products illustrated
in this catalogue
and declines all
responsibility for any
inaccuracies contained
in it. Textures and
colours of materials and
finishes are indicative
as they are subject
to the tolerances of
printing processes.

Horm Italia Srl se
réserve le droit
d'apporter, à tout
moment et sans
notification préalable,
des modifications
et/ou des améliorations
de type technique ou
esthétique aux produits
illustrés dans le présent
catalogue, et décline
toute responsabilité
pour les éventuelles
inexactitudes
contenues dans ce
catalogue. Les textures
et les couleurs des
matériaux et des
finitions sont une valeur
indicative parce-que
ils changent selon la
tolérance aux procédés
d'imprimerie.

Horm Italia Srl behält
sich das Recht vor,
jederzeit und ohne
vorherige, Ankündigung
Änderungen
und/oder technische
oder ästhetische
Verbesserungen an
den im vorliegenden
Katalog dargestellten
Produkten vorzunehmen,
und übernimmt keine
Verantwortung
für eventuelle
darin enthaltene
Ungenauigkeiten. Die
Texturen und Farben
der Materialien und
Finish haben einen
indicativen Wert, da sie
von den Toleranzen im
Druckprozess abhängig
sind.

Horm Italia Srl se
reserva la facultad de
aportar, en cualquier
momento y sin previo
aviso, cambios y
mejoras de carácter
técnico o estético a los
productos ilustrados
en este catálogo,
y se exime de toda
responsabilidad
por cualesquiera
inexactitudes que
éste catálogo pueda
contener. Las textures
y los colores de los
materiales y de los
acabados tienen solo
un valor indicativo
porque están sujetos
a la tolerancia de los
procesos de imprenta.

