

TAMA LIVING Design: EOOS.



Tama Living is the setting for the special moment. A clear picture of symmetry, lines and surface, giving the sofa the opportunity to reveal its rhythm: gaps in the backrest make the sheer volume seem less. Side tables featuring the best saddle leather pleasantly nestle up against the upholstery. And there is a special place for that glass of wine, too: not beside but in the sofa – the tray made of solid wood and saddle leather makes sure of that. An ingenious tune on a keyboard of hushed tones. Tama Living – a sofa like a piece of classical music. A composition for cultivated living.

Product description

Modell no.

820

Frame

Aluminium-Frame:

- powder-coated black matt
- powder-coated bronze matt

Frame:

Beech frame with zigzag springs.

Armrest and back:

Wooden construction.

Upholstery

Seat cushion:

Version 1 (casual look): ticking sewn into chambers with down filling and cold cure coresandwich construction. *Notice: The visibleness of ticking chambers is a feature of quality for this version.*

Version 2 (formal look): cold cure core sandwich construction with an outer layer of wadding.

Cushions:

Back cushions: ticking sewn into chambers with down filling and cold cure core.
Comfort cushion: loose, ticking sewn into chambers with down/fibre filling.

For the long version elements, a tray or small seat cushion must be ordered separately:

Tray:

Solid wood frame, with a veneered floor to match the wood. Available in:

- Oak white pigmented, geölt (.10wo)
- Oak fumed, oiled (.13wo)
- Oak burned, oiled (.14wo)
- nutwood with sapwood incl. (.99wo)

Surface level with the blades. Sliding tray in saddle leather, available in coffee or black.

small seat cushion:

available in **Version 1** (casual look) and **Version 2** (formal look).

Legs

Solid Wood blades:

- Oak white pigmented, oiled (.10wo)
 - Oak fumed, oiled (.13wo)
 - Oak burned, oiled (.14wo)
 - nutwood with sapwood incl. (.99wo)
-

TAMA LIVING

Seat height

Seat height 43 cm (overall height 85 cm).
All elements also available with a seat height
of 45 cm (overall height 87 cm).

Headrest

Fully upholstered in fabric or leather.
Band in coffee or black saddle leather to attach the neck roll to the headrest.

Roll: ticking sewn into chambers with latex rod/down filling.

Glides

Fitted with felt glides for wooden floors or stoppers to avoid sliding.

Occasional tables

Side Table:

The Side Tables are connected to the upholstery element with a plug Connection.
(*Delivery in two sections*)

The blades and the frame are matches to the upholstery element as well as to the aluminum-frame.

Table top: saddle leather, coffee or black.

Ordering notes

All the elements in the range can be free-standing!

The Tama Living programme offers a variety of elements which are created with the combination of at least two elements.

Please select the elements for your order from left to right. For a combination of several Tama Living elements, please add a drawing.

A locking device for connecting the elements can only be preassembled at the factory if a planning sketch is available.

Notice

- The cushions 820-RK1, 820-RK2 and 820-CK1 shown and listed with the article numbers are included in the prices.

- All the covers can be removed.

- **Delivery:** The seat cushions lie loosely on the base. Seat and back are delivered in one section. **The maximum length of the elements on shipment is 290 cm** (820-25 L ESL/ESR, 820-25 L AL/AR and 820-25 M LL/LR). If necessary, the group should be created out of smaller elements.

TAMA LIVING

Technical drawings and dimensions

820-20

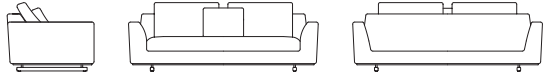

B/W 232 T/D 109 H85
SH 43/45 ST/SD 60 AH 61

820-25

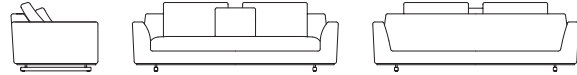

B/W 260 T/D 109 H85
SH 43/45 ST/SD 60 AH 61

820-10 R

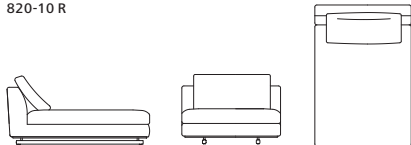

B/W 121 T/D 177 H85
SH 43/45

820-10 R STR/STL

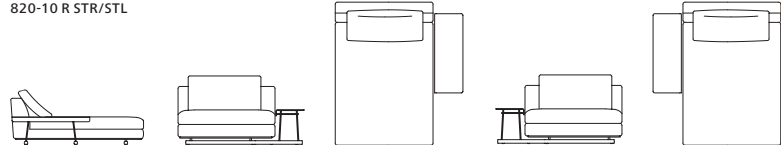

B/W 158 T/D 177 H85
SH 43/45

820-20 ESR AL/ESL AR

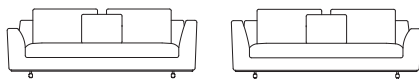

B/W 235 T/D 109 H85
SH 43/45 ST/SD 60 AH61

820-25 ESR AL/ESL AR

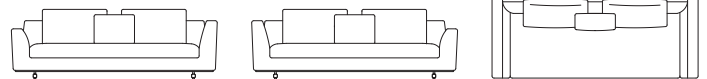

B/W 260 T/D 109 H85
SH 43/45 ST/SD 60 AH 61

820-10 ESL/ESR

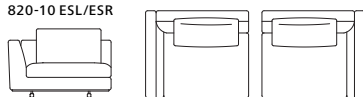

B/W 135 T/D 109 H85
SH 43/45 ST/SD 60

820-15 ESL/ESR

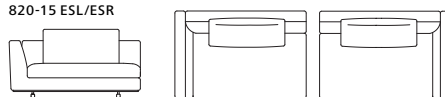

B/W 165 T/D 109 H85
SH 43/45 ST/SD 60

820-20 ESL/ESR

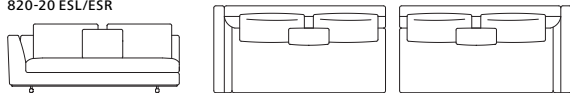

B/W 215 T/D 109 H85
SH 43/45 ST/SD 60

820-25 ESL/ESR

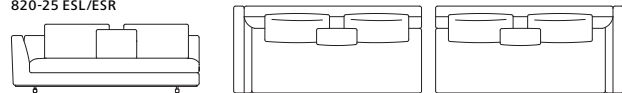

B/W 240 T/D 109 H85
SH 43/45 ST/SD 60

820-10 L ESL/ESR

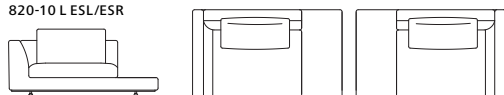

B/W 185 T/D 109 H85
SH 43/45 ST/SD 60

820-15 L ESL/ESR

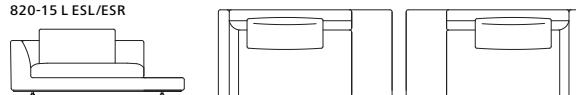

B/W 215 T/D 109 H85
SH 43/45 ST/SD 60

820-20 L ESL/ESR

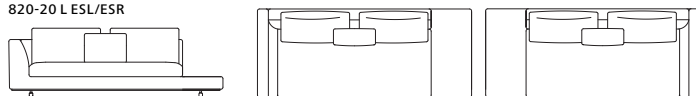

B/W 265 T/D 109 H85
SH 43/45 ST/SD 60

820-25 L ESL/ESR

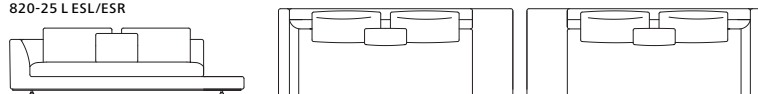

B/W 290 T/D 109 H85
SH 43/45 ST/SD 60

All dimensions in cm.

TAMA LIVING

820-10 AL/AR

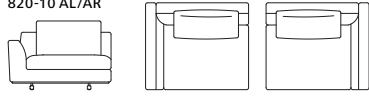

B/W 131 T/D 109 H 85
SH 43/45 ST/SD 60 AH 61

820-15 AL/AR

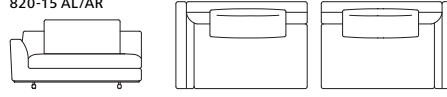

B/W 161 T/D 109 H 85
SH 43/45 ST/SD 60 AH 61

820-20 AL/AR

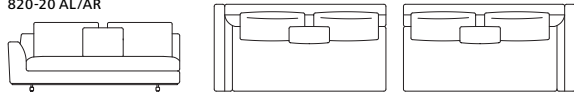

B/W 211 T/D 109 H 85
SH 43/45 ST/SD 60 AH 61

820-25 AL/AR

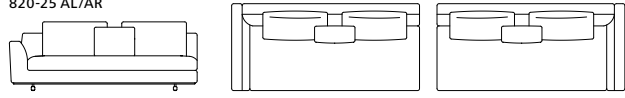

B/W 236 T/D 109 H 85
SH 43/45 ST/SD 60 AH 61

820-10 L AL/AR

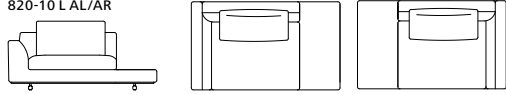

B/W 184 T/D 109 H 85
SH 43/45 ST/SD 60 AH 61

820-15 L AL/AR

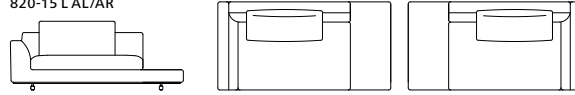

B/W 214 T/D 109 H 85
SH 43/45 ST/SD 60 AH 61

820-20 L AL/AR

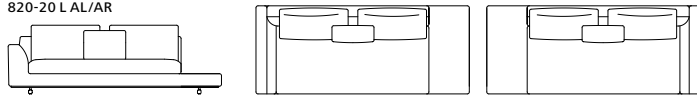

B/W 264 T/D 109 H 85
SH 43/45 ST/SD 60 AH 61

820-25 L AL/AR

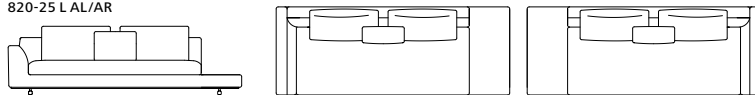

B/W 289 T/D 109 H 85

820-10 M

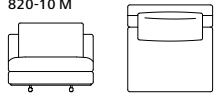

B/W 110 T/D 109 H 85
SH 43/45 ST/SD 60

820-15 M

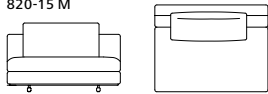

B/W 140 T/D 109 H 85
SH 43/45 ST/SD 60

820-20 M

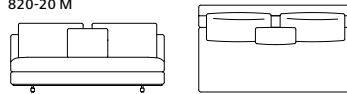

B/W 190 T/D 109 H 85
SH 43/45 ST/SD 60

820-25 M

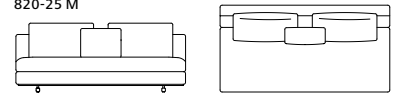

B/W 215 T/D 109 H 85
SH 43/45 ST/SD 60

820-10 M LL/LR

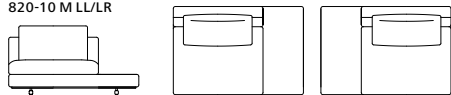

B/W 161 T/D 109 H 85
SH 43/45 ST/SD 60

820-15 M LL/LR

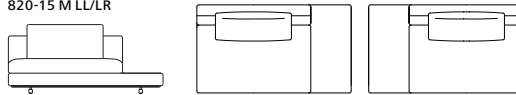

B/W 191 T/D 109 H 85
SH 43/45 ST/SD 60

820-20 M LL/LR

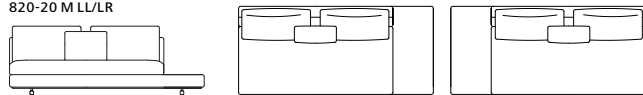

B/W 241 T/D 109 H 85
SH 43/45 ST/SD 60

820-25 M LL/LR

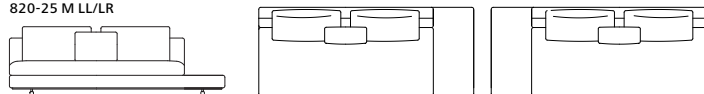

B/W 266 T/D 109 H 85
SH 43/45 ST/SD 60

All dimensions in cm.

TAMA LIVING

820-10 E STR/STL

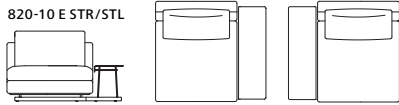

B/W 141 T/D 128 H 85
SH 43/45

820-15 STR/STL

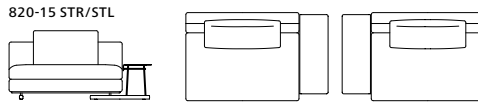

B/W 176 T/D 109 H 85
SH 43/45 ST/SD 60

820-20 STR/STL

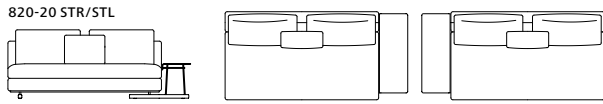

B/W 226 T/D 109 H 85
SH 43/45 ST/SD 60

820-25 STR/STL

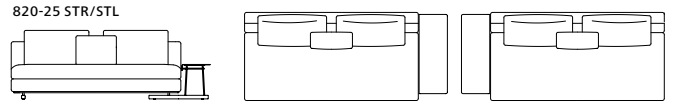

B/W 251 T/D 109 H 85
SH 43/45 ST/SD 60

820-RK 1



53 x 85

820-RK 2



53 x 94

820-CK 1



52 x 52

820-K



B/W 50
T/D 109
H 18

820-T



B/W 50
T/D 109
H 7

820-NKR



B/W 60
T/D 15
H 71

Beispielkonfigurationen_ Configuration examples

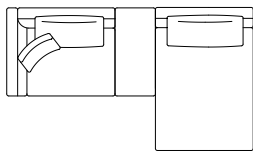

VERSION A:
820-CK 1 + 820-10 L AL + 820-K + 820-10 R
B/W 305 T/D 177

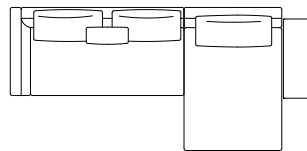

VERSION B:
820-20 AL + 820-10 R STR
B/W 369 T/D 177

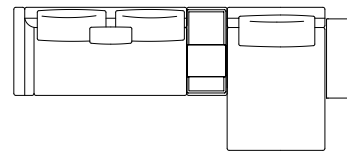

VERSION C:
820-20 L AL + 820-T + 820-10 R STR
B/W 422 T/D 177

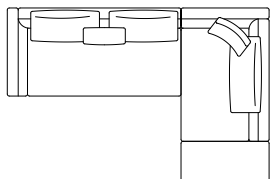

VERSION D:
820-20 AL + 820-CK 1 + 820-15 L ESL + 820-K
B/W 320 T/D 265

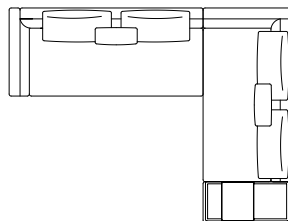

VERSION E:
820-25 ESL + 820-20 L ESL + 820-T
B/W 343 T/D 265

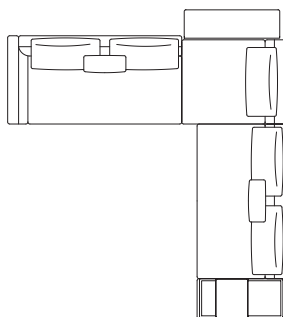

VERSION F:
820-20 AL + 820-10 E STL + 820-20 M LR + 820-T
B/W 339 T/D 382

All dimensions in cm.

TAMA LIVING.

Ergänzende Bestellhinweise zu den Sofavarianten

Es gibt **vier Sitzkissenbreiten** für das Programm Tama Living für alle Sofas, Eckanreih-Sofas, Anreih-Sofas sowie für die Zwischen- & Abschlusselemente. Abschlusselemente mit Side Table sind ab einer Breite von 140 cm erhältlich.

1-Sitzer Sitzkissenbreite	110 cm
1,5-Sitzer Sitzkissenbreite	140 cm
2-Sitzer Sitzkissenbreite	190 cm
2,5-Sitzer Sitzkissenbreite	215 cm

Eckanreih-Sofas

Alle Eckanreih-Sofas haben eine umlaufende Rückenhöhe (die Armlehne ist so hoch wie der Rücken).



Anreih-Sofas

Alle Anreih-Sofas haben eine Armlehne (die Armlehne ist niedriger als der Rücken).



Zwischen- & Abschlusselemente und Recamieren

Diese Elemente können als Zwischen- & Abschlusselemente verwendet werden.



Abschlusselemente, Recamieren und Eckelemente mit Side Table

Abschlusselemente mit Side Table, Recamieren mit Side Table und Eckelemente mit Side Table haben jeweils einen offenen Abschluss und einen Side Table als Abschluss. Nur an die Seite mit offenem Abschluss kann ein weiteres Element angebaut werden.

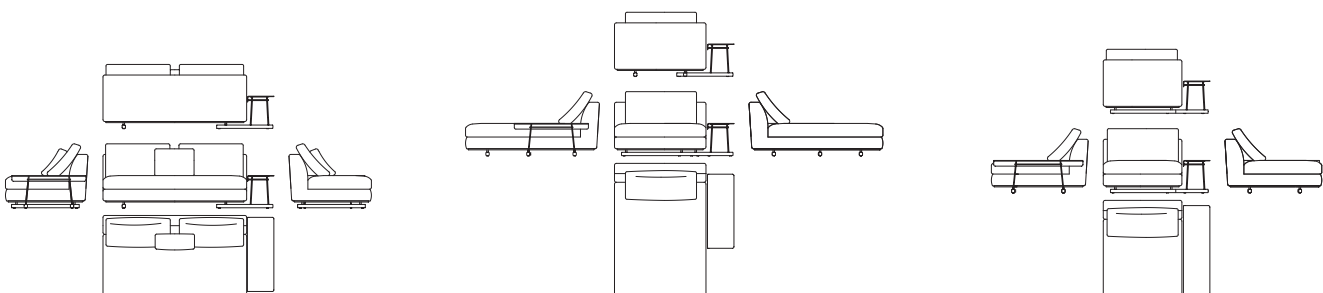

Tray und kleines Sitzkissen für die Long Versions

Neben den vier Sitzkissenbreiten gibt es die Möglichkeit, den Abschluss der Long Versions mit einem Tray oder einem kleinen Sitzkissen offen zu gestalten (keine Rückenlehne), dies gilt für alle Sitzkissenbreiten:

- Eckanreih-Sofa Long Versions
- Anreih-Sofa Long Versions
- Zwischen- & Mittelelement Long Versions

Das **L** in der Artikelnummer 820-20 **L** AR steht für **Long Version**.

Beispiel der verschiedenen Abschlüsse anhand des 2-sitzigen Anreihsofas Long Version.

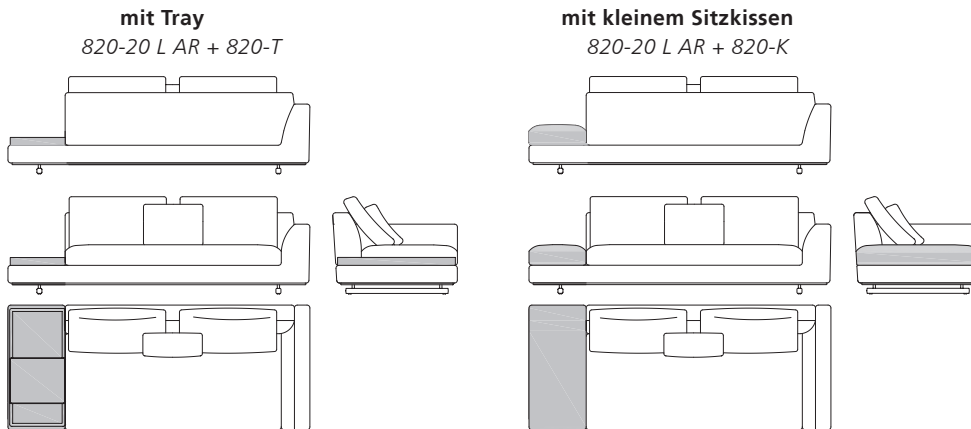

Das **T** in der Artikelnummer **820-T** steht für **Tray**.

Das **K** in der Artikelnummer **820-K** steht für **kleines Sitzkissen**.

Beispielkonfiguration

Alle Elemente des Programms können frei stehen.

Das Programm Tama Living bietet eine Vielzahl an Varianten, die durch die Kombination von mindestens zwei Elementen entstehen.

Beginnen Sie in der Anbau-Reihenfolge von links nach rechts (**1 - 4**), ausgehend vom linken Element (**1**).

