BuzziShade Square

220-240V

Product Specification Sheet

This document contains technical information about the BuzziShade Square



www.buzzi.space







A reinvented classic

Thanks to BuzziShade Square and BuzziShade Square Beam's sleek and architectural design language, both options perfectly suit all kinds of workspaces, should they be in an office, education center, hospitality space, or beyond. The acoustic lighting solution doubles as a sound-absorbing panel and can be paired with either a Globe or Spot iteration of BuzziSol Solo (BuzziShade Square Medium only) and BuzziSol Trio (BuzziShade Square Beam only). BuzziShade Square can be outfitted in various BuzziFelt color combinations.

Designed by Stal Collectief

General

-  Medium | Beam
-  BuzziFelt cover
Powder coated metal frame
Fabric power cord
-  Input Voltage: 220 - 240V
Input Frequency: 50/60Hz
-  Dry usage
-  Assembled

Acoustics



Absorption



Diffusion



Mid tone



High tone

Certifications

CE/CB

Content

Configurations	3
Technical components	4
Fabrics	7
Photometric Data	8
Dimensions	10
Acoustics	12

Configurations

BuzziShade Square Medium

- ◆ Medium
- ◆ BuzziFelt cover with lace
- 🌲 Metal frame in black (RAL 9005), white (RAL 9010), alu (RAL 9006) or fluorescent orange (RAL 2005)*
- Height: 44 cm
- ✂ Width: 75 cm
- Depth: 75 cm
- 💡 E27 Fitting (Max. 60W)
- Excl. Bulb
- ⚖ 5 kg
- ◆ Lace: black | white | fluorescent orange
- ◆ Black or alu cables 2 - 5 m
- ◆ Fabric power cord in black, red or fluorescent orange
- ◆ Ceiling canopy black or white
- ⚠ If installing on suspended ceiling, verify load capacity prior to installation.

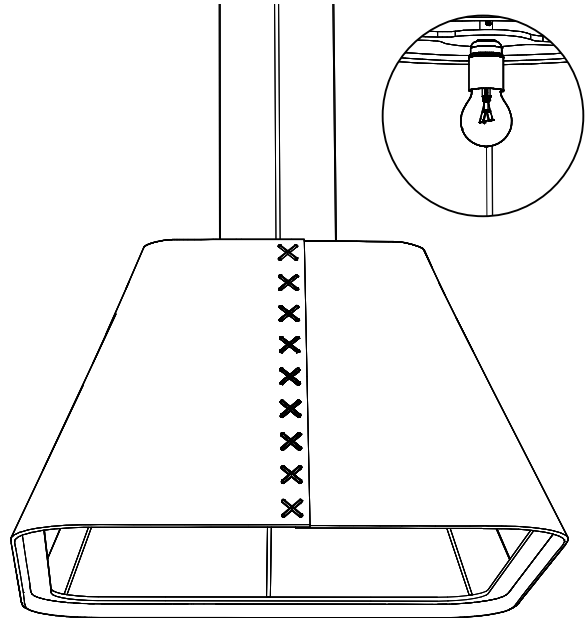

BuzziShade Square LED Medium

- ◆ Medium
- ◆ BuzziFelt cover with lace
- ◆ Metal frame in black (RAL 9005), white (RAL 9010), alu (RAL 9006) or fluorescent orange (RAL 2005)*
- ◆ Fabric power cord in black
- ◆ Ceiling canopy black
- Height: 44 cm
- ✂ Width: 75 cm
- Depth: 75 cm
- Wattage: 32W
- Lumen Output: 1500 lumen (LED light source)
- 💡 Color Temperature: 3000K
- Color Rendering Index: 90
- Dimmable: 1-10V Protocol (DALI on request)
- ⚖ 7 Kg
- ◆ Diffusor: frosted glass globe or 38° reflector spot
- ◆ Lace: black | white | fluorescent orange
- ◆ Black or alu cables 2 - 5 m
- ⚠ If installing on suspended ceiling, verify load capacity prior to installation

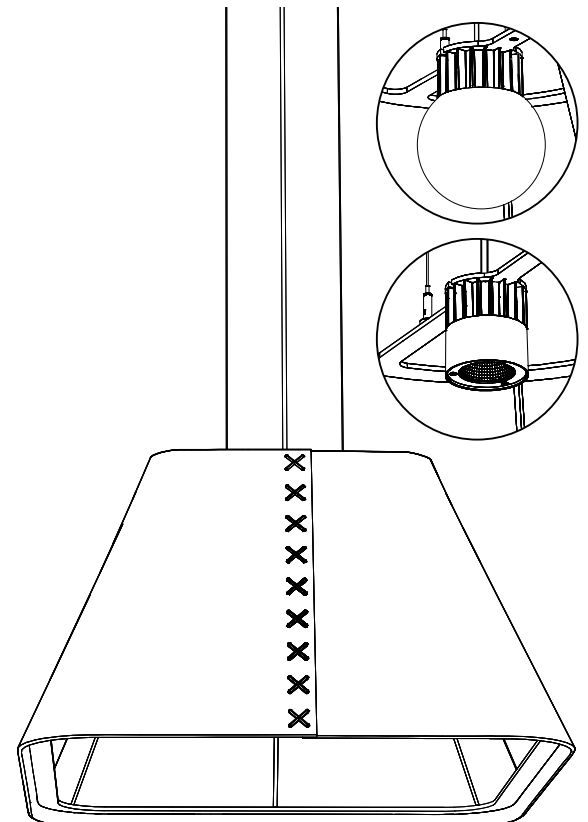

*Until end of stock

BuzziShade Square Beam

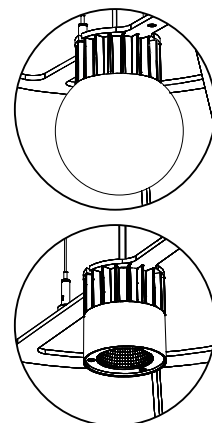
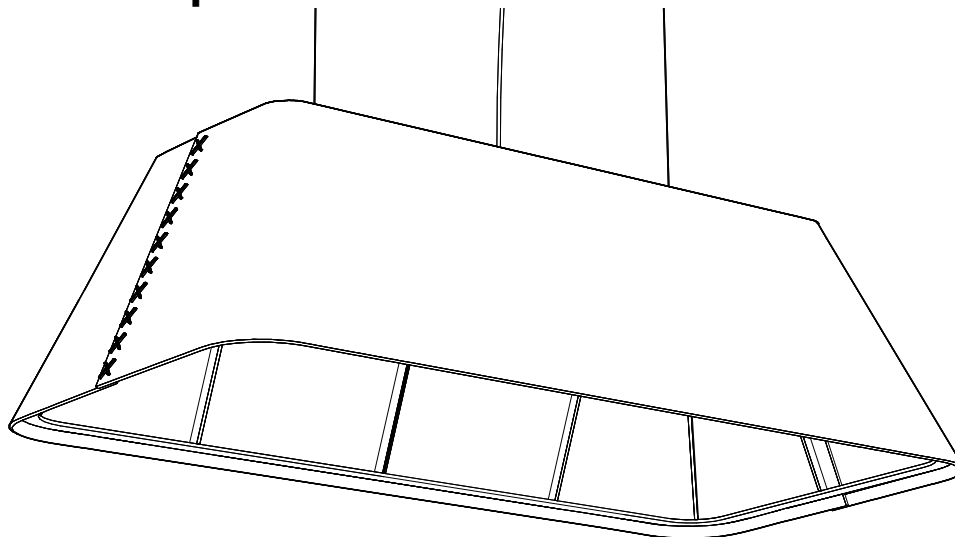

Beam

BuzziFelt cover with lace



Metal frame in black (RAL 9005), white (RAL 9010), alu (RAL 9006)

Fabric power cord in black

Ceiling canopy black

Height: 44 cm



Width: 151 cm

Depth: 75 cm

Wattage: 3 x 32W

Lumen Output: 3x 1500 lumen (LED light source)



Color Temperature: 3000K

Color Rendering Index: 90

Dimmable: 1-10V Protocol



12,7 kg

Diffusor: frosted glass globe or 38° reflector spot



Lace: black | white | fluorescent orange

Black or alu cables 2 - 5 m



If installing on suspended ceiling, verify load capacity prior to installation

Technical components

BuzziShade Square Medium Retrofit

Ceiling canopy

Powder coated metal canopy in black (RAL 9005) or white (RAL 2010)

Including mounting bracket

Height: 2,6 cm

Diameter: 12 cm



Frame

Metal frame available in following colors:

Powder coated white	RAL 9010
Powder coated black	RAL 9005
Fluorescent orange	RAL 2005*
Alu	not powder coated

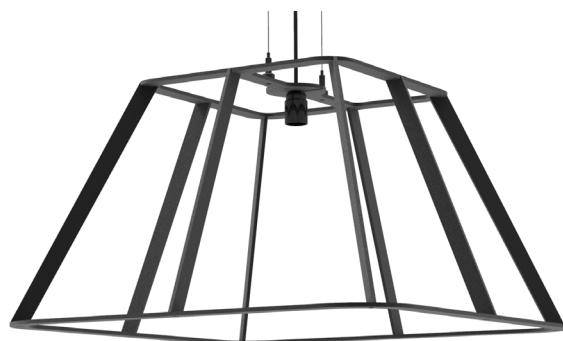

*Until end of stock

Light Source Shade Square Medium

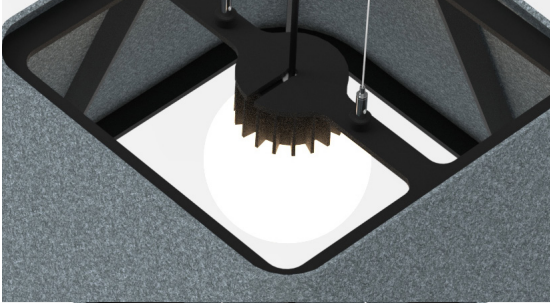

LED light source with powder coated metal heat sink and ceiling canopy in black (RAL 9005) finished with a frosted glass sphere or a 38° reflector spot.

Globe (incl. heat sink)

Height: 20 cm

Width: Ø 15 cm

Spot (incl. heat sink)

Height: 11 cm

Width: Ø 10 cm

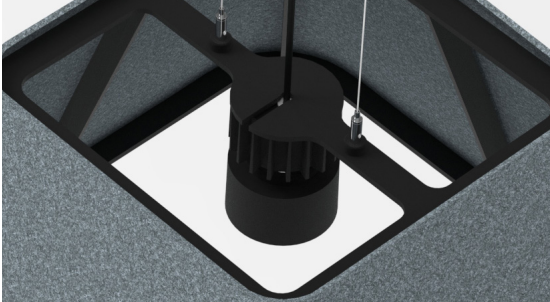

Light Source Shade Square Beam

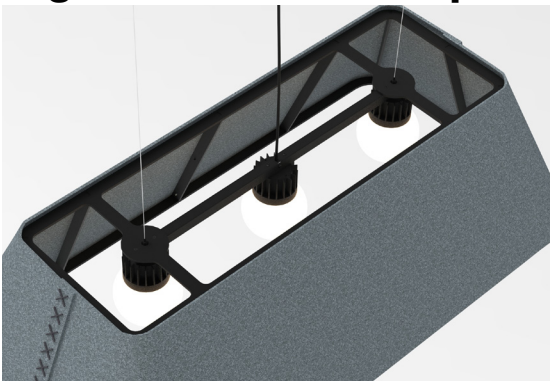

LED light source with powder coated metal heat sink and ceiling canopy in black (RAL 9005) finished with 3 frosted glass spheres or 3 38° reflector spots.

Globe (incl. heat sink)

Height: 20 cm

Width: Ø 15 cm

Spot (incl. heat sink)

Height: 11 cm

Width: Ø 10 cm

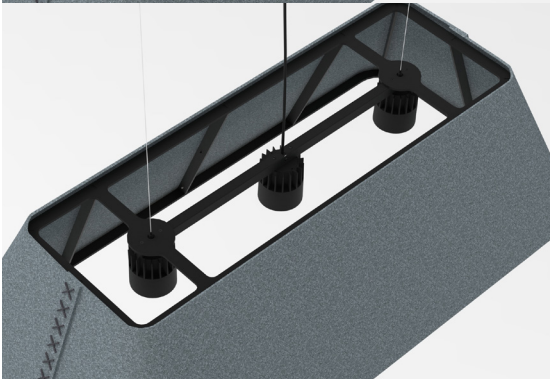

Ceiling canopy Shade Square Medium



Black metal ceiling canopy and black fabric power cable incl. Fixing System Screw with 1 alu or black cable of 2 m or 5 m

Width: 14 cm
Length: 28 cm
Height: 4 cm

Ceiling canopy Shade Square Beam



Black metal ceiling canopy and black fabric power cable incl. Fixing System Screw with 2 alu or black cables of 2 m or 5 m

Width: 12,5 cm
Length: 35 cm
Height: 4,5 cm

Heat sink



The light element consists out of a black powder coated metal heat sink fitted with a C.O.B. LED source.

BuzziProp Small: 1 x heat sink
BuzziProp Beam: 3 x heat sink

Globe

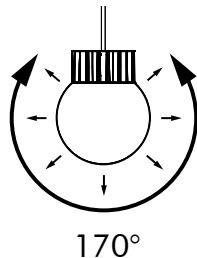

The BuzziSol Globe is finished with a frosted glass globe, to create a decorative light effect 170° around enlightening the beautifully crafted upholstery.

Specification overview

Standard: 3000K | 1-10V DIM

On request (only for BuzziProp Small): 3000K | DALI DIM

BuzziShade Square Medium: 1 x frosted glass globe

BuzziShade Square Beam: 3 x frosted glass globe

Spot

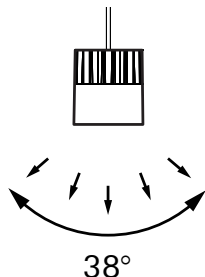

The BuzziSol Spot is finished with a 38° reflector to direct the light towards the surface.

Specification overview

Standard: 3000K | 1-10V DIM

On request (only for BuzziProp Small): 3000K | DALI DIM

BuzziShade Square Medium 1 x 38° reflector

BuzziShade Square Beam: 3 x 38° reflector

Frame Shade Square Medium



Metal frame available in following colors:
Powder coated white | RAL 9010
Powder coated black | RAL 9005
Fluorescent orange | RAL 2005*
Alu | not powder coated

*Until end of stock

Frame Shade Square Beam

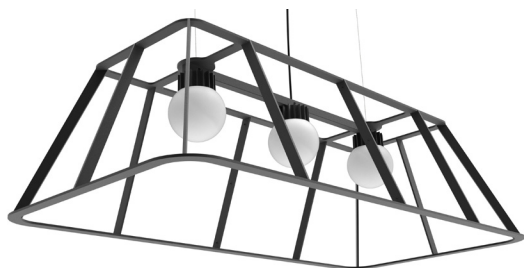

Metal frame available in following colors:
Powder coated white | RAL 9010
Powder coated black | RAL 9005
Alu | not powder coated

Fabrics

Felt

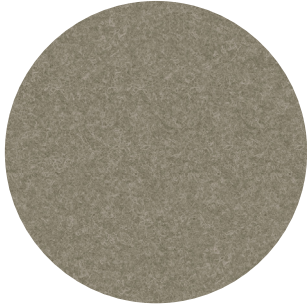

Composition 100% Recycled PE.T. Felt, latex backing

Weight 1.000 g/m2 | 29.49 oz/yd2

Abrasion resistance >7.000 Martindale

Flammability EU: EN 13501.1 + A1/2009 Class B-s1,d0
USA: ASTM E84 Class A certified

Fastness to light USA 5



Lace

Lace black | white | fluorescent orange



Photometric Data

BuzziShade LED Globe

To enlight your room with a lux level of 100 lux take following measures into account.

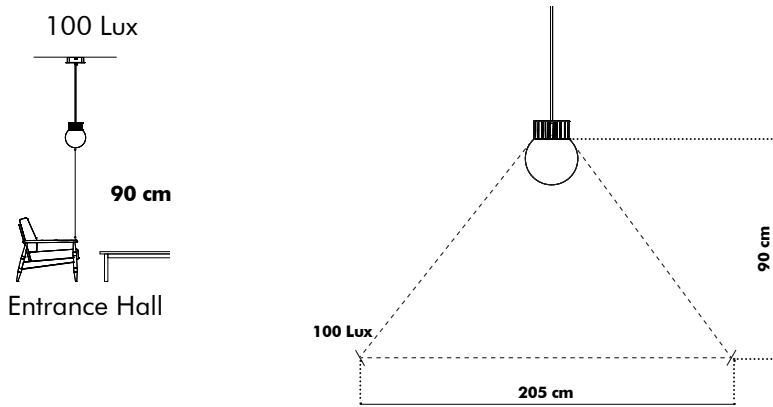

* According to EN12464

Globe Cartesian diagram

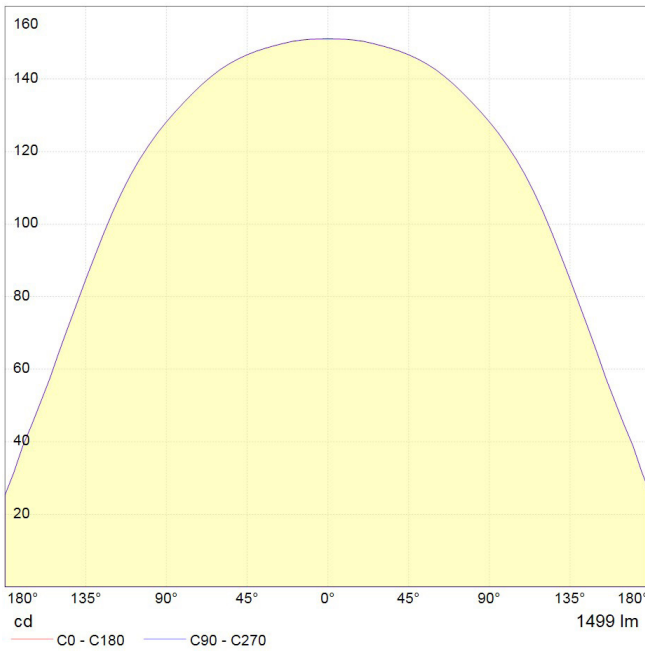

Globe Polar curve

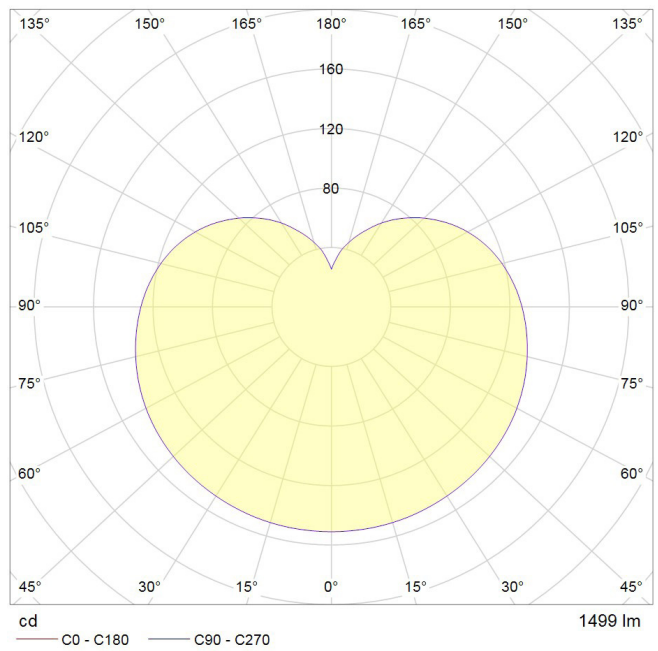

BuzziShade LED Spot

To enlight your workplace or room with optimal lux levels take following measures into account.

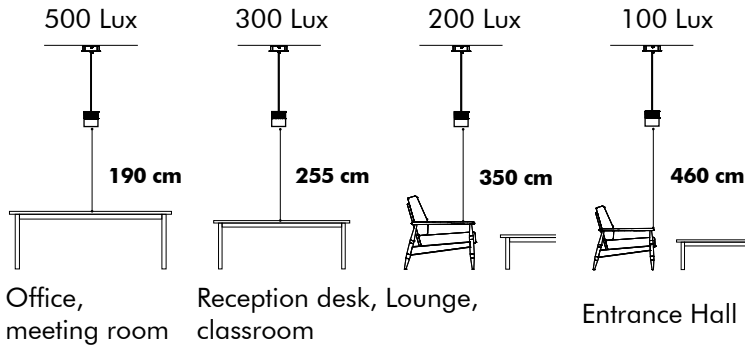

* According to EN12464

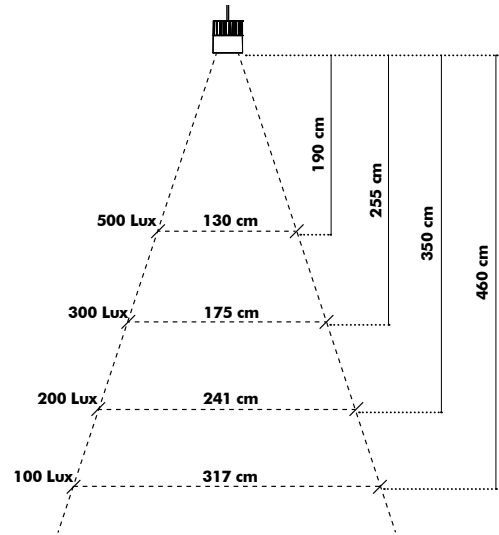

Globe Cartesian diagram

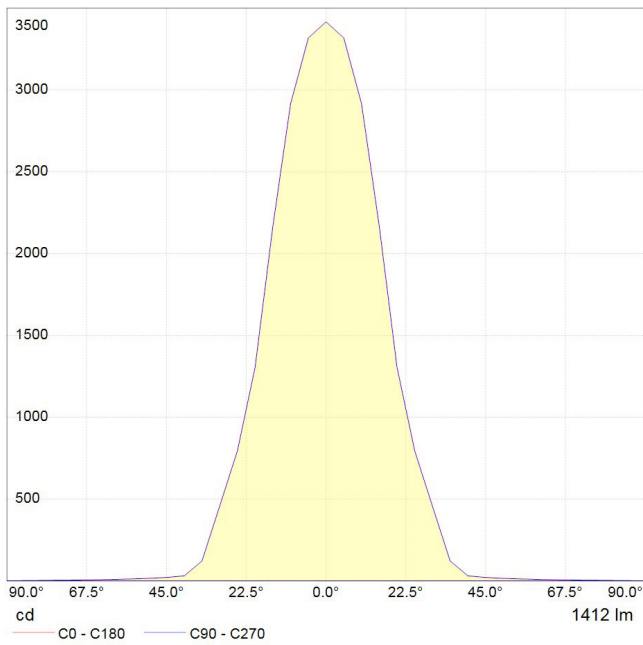

Globe Polar curve

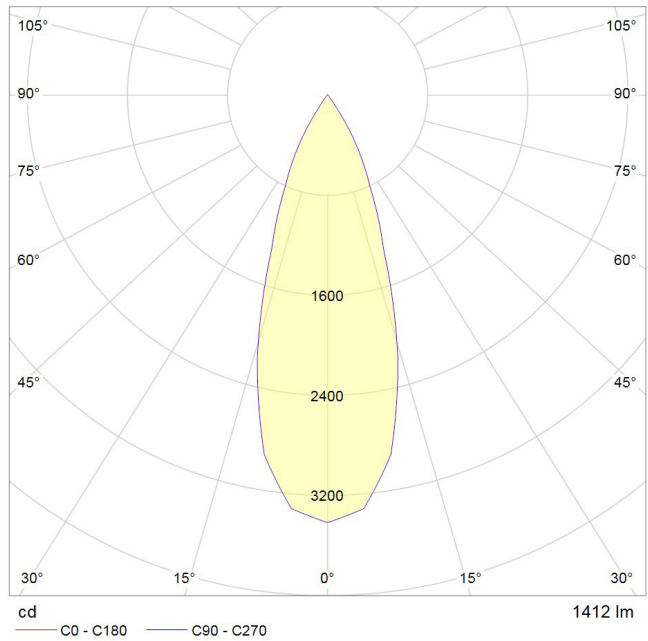

Dimensions

BuzziShade Square Medium

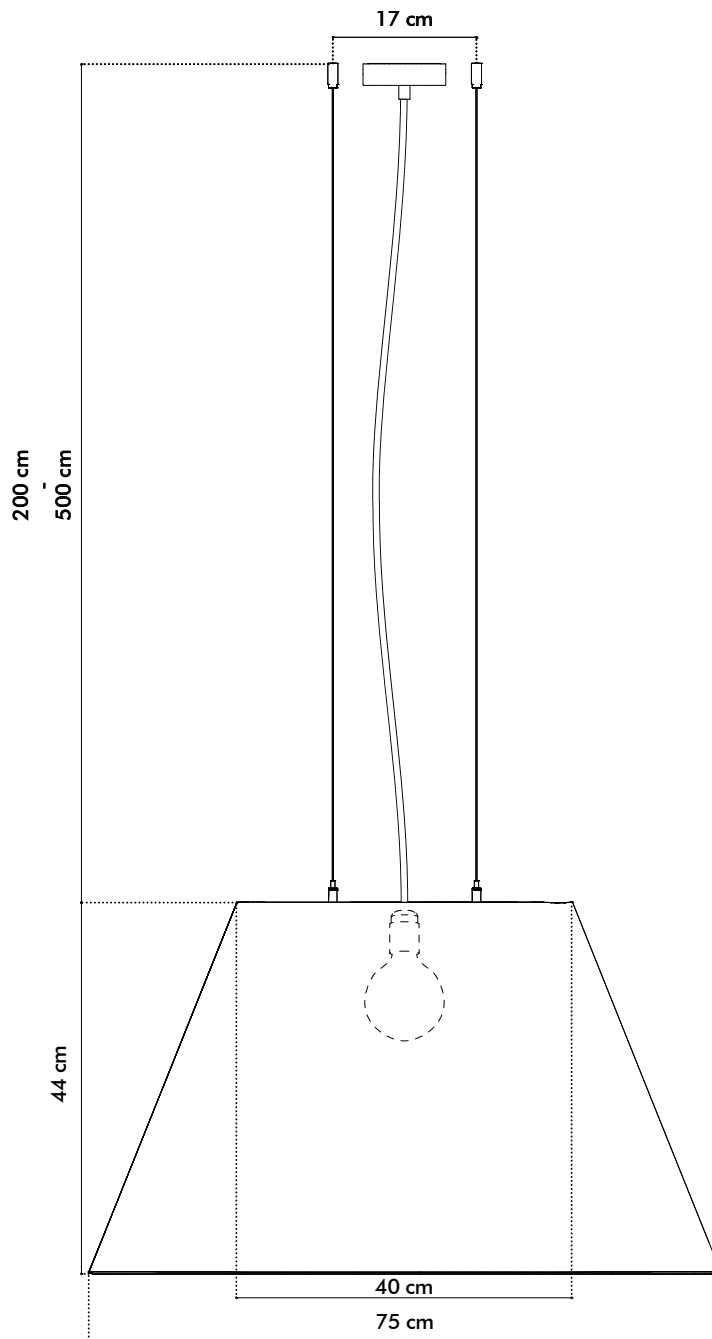

BuzziShade Square LED Medium

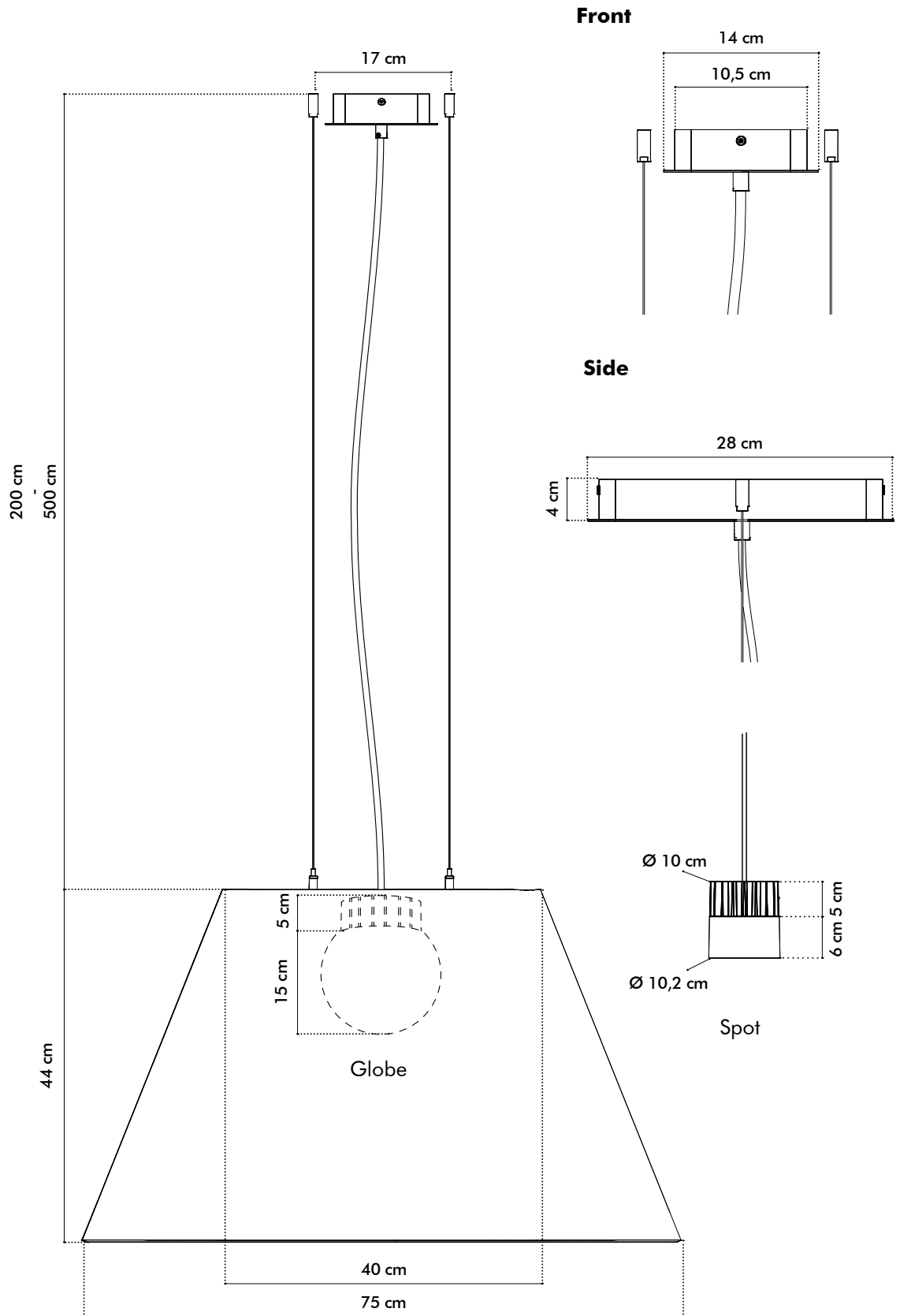

BuzziShade Square LED Beam

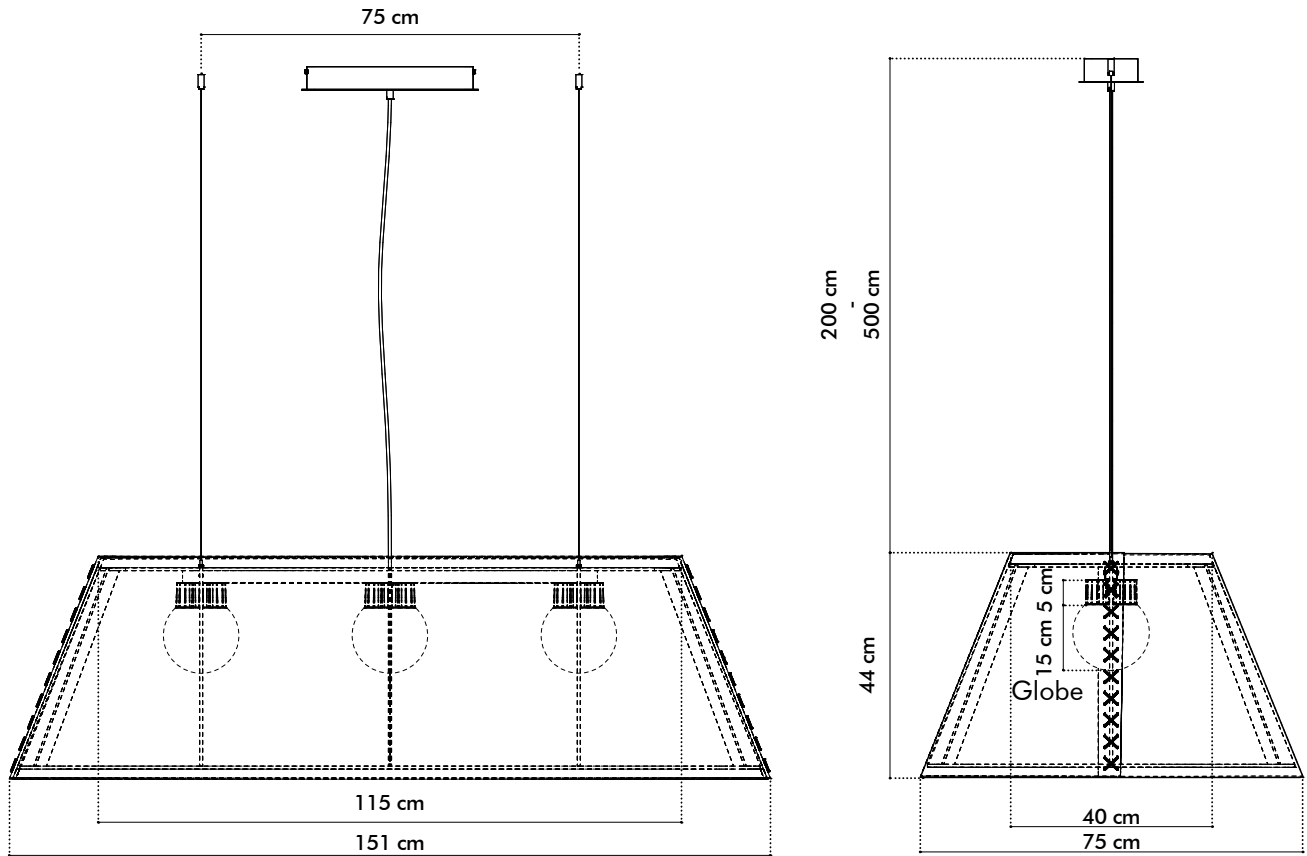

Front

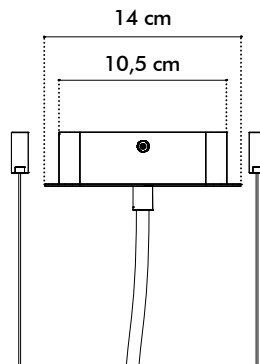

Side

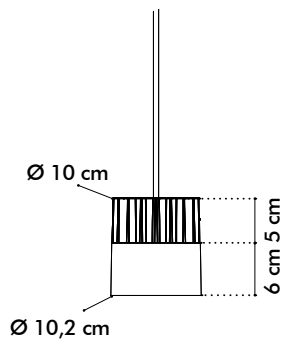
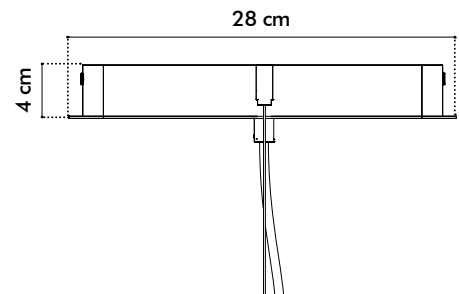

Spot

Acoustics

BuzziShade Square

Equivalent sound absorption area in m² per object

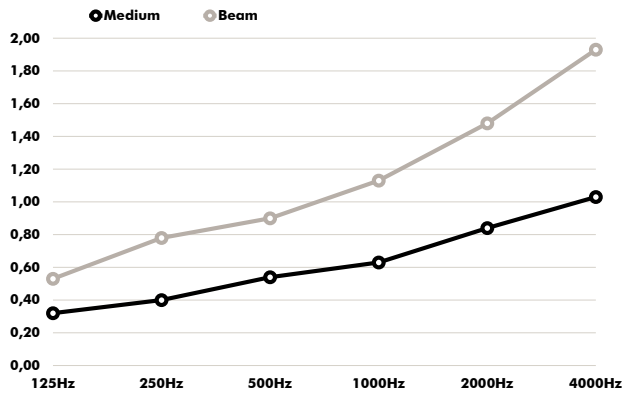

Hz	Aeq/m ² Medium	Aeq/m ² Beam
125	0,32	0,53
250	0,40	0,78
500	0,54	0,90
1000	0,63	1,13
2000	0,84	1,48
4000	1,03	1,93