BuzziTripl Desk Split Product Specification Sheet

This document contains technical
information about the BuzziTripl Desk Split



www.buzzi.space







Three for two

Meet this desk partition made of 3 layers of felt that divides any desk into 2 workstations. Not only is BuzziTripl Desk Split ideal for dividing a communal table and creating private and individual workstations, its noise-reducing capabilities will also help employees to improve their much-needed focus.

Design by BuzziSpace Studio

General

-  BuzziTripl Desk Split
-  Outside layers: BuzziFelt 6 mm | 0.24" (both sides)
Core: Furniture Felt 6 mm | 0.24"
-  Dry use
-  Flat Packed
Desk mounted
-  2 shapes: round corners or wedge

Acoustics



Absorption



Attenuation



Mid tone



High tone

Certifications



Content

Configuration	3
Shapes	3
Fixes	3
Fabrics	4
Dimensions	5
Acoustics	8

Configurations

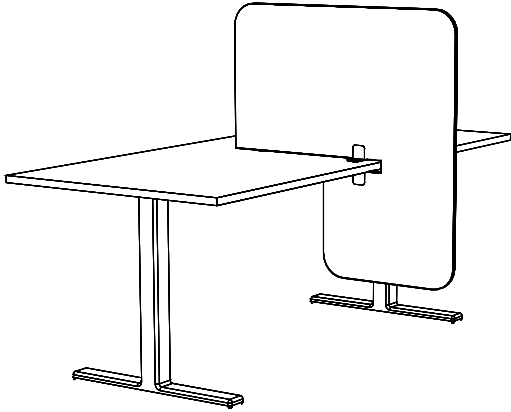

- 🔑 BuzziTripl Desk Split
- 🌲 Outside layers: BuzziFelt 6 mm | 0.24" (both sides)
Core: Furniture Felt 6 mm | 0.24"
- ⚖️ 3,75 kg/m² | 0.77 lbs/ft²
- ⋯ 2 shapes: round corners or wedge

Shapes

Round Corners

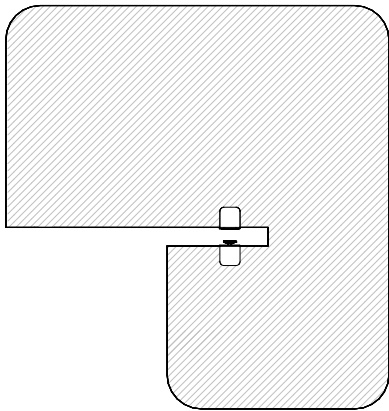

Wedge

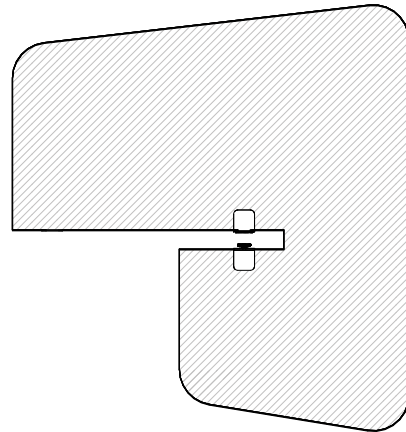

Fixes (included)

Fixes are available in powder coated metal Black (RAL 9005) or White (RAL 9010)

Fix Foot (top)

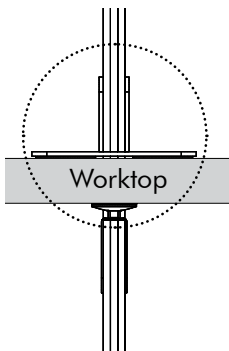

Two antiskid pads underneath the fix

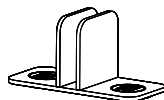

Split Fix (underneath)

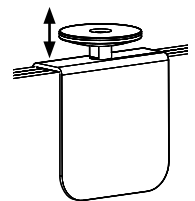
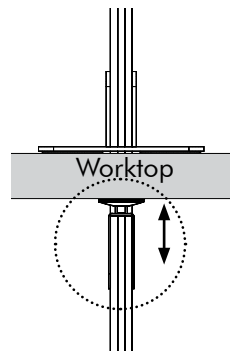

Fabrics

Felt

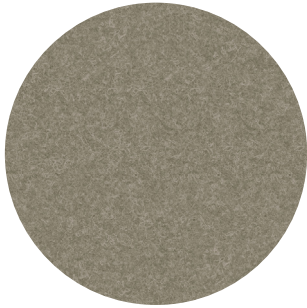

Composition 100% Recycled PE.T. Felt, latex backing

Weight 1.000 g/m2 | 29.49 oz/yd2

Abrasion resistance >7.000 Martindale

Flammability EU: EN 13501.1 + A1/2009 Class B-s1,d0
USA: ASTM E84 Class A certified

Fastness to light USA 5



*Not available in Ecobrown 58

Dimensions

Round Corners

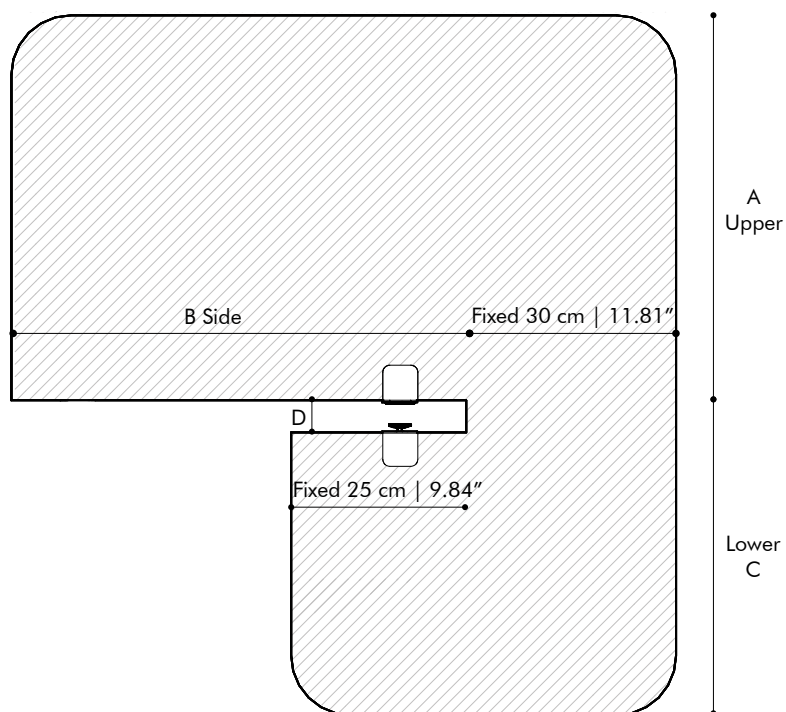

Thickness

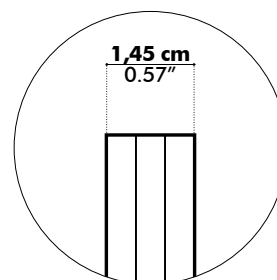

	A	B	C
S	40 cm 15.75"	45 cm 17.72"	25 cm 9.84"
			45 cm 17.72"
		65 cm 25.59"	25 cm 9.84"
			45 cm 17.72"
M	45 cm 17.72"	45 cm 17.72"	25 cm 9.84"
			45 cm 17.72"
		65 cm 25.59"	25 cm 9.84"
			45 cm 17.72"
L	50 cm 19.69"	45 cm 17.72"	25 cm 9.84"
			45 cm 17.72"
		65 cm 25.59"	25 cm 9.84"
			45 cm 17.72"
XL	55 cm 21.65"	45 cm 17.72"	25 cm 9.84"
			45 cm 17.72"
		65 cm 25.59"	25 cm 9.84"
			45 cm 17.72"

Worktop Thickness	D	
12 > 28 mm 0.47" > 1.10"	4,1 cm 1.61"	Fix included
29 > 42 mm 1.14" > 1.65"	5,7 cm 2.24"	Fix included
43 > 56 mm 1.69" > 2.20"	7,1 cm 2.80"	Fix included

Wedge

Thickness

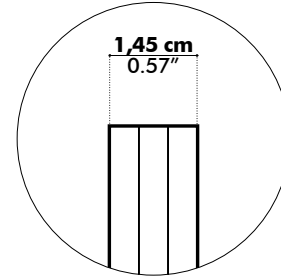
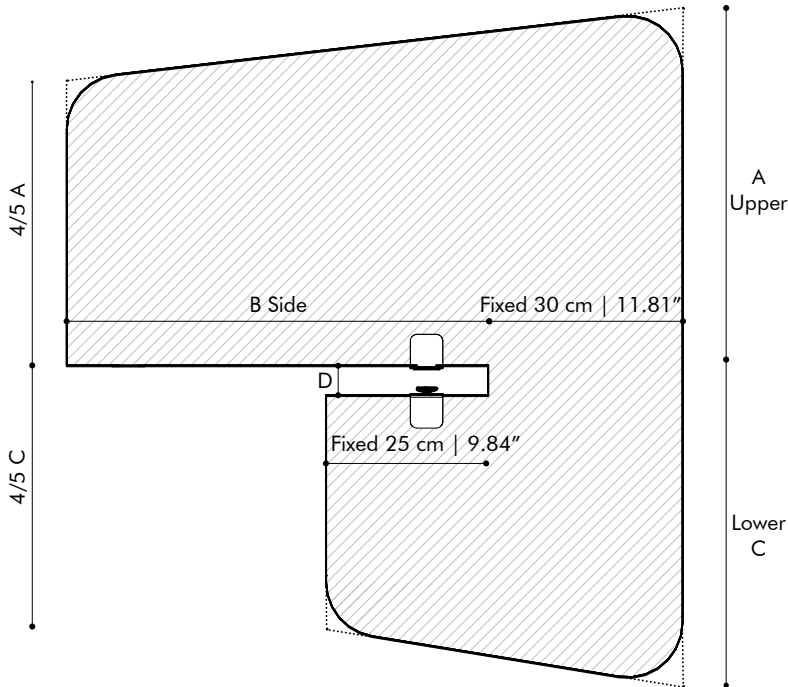

	A	B	C
S	40 cm 15.75"	45 cm 17.72"	25 cm 9.84"
			45 cm 17.72"
		65 cm 25.59"	25 cm 9.84"
M	45 cm 17.72"	45 cm 17.72"	25 cm 9.84"
			45 cm 17.72"
		65 cm 25.59"	25 cm 9.84"
L	50 cm 19.69"	45 cm 17.72"	25 cm 9.84"
			45 cm 17.72"
		65 cm 25.59"	25 cm 9.84"
XL	55 cm 21.65"	45 cm 17.72"	25 cm 9.84"
			45 cm 17.72"
		65 cm 25.59"	25 cm 9.84"

Worktop Thickness	D	
12 > 28 mm 0.47" > 1.10"	4,1 cm 1.61"	Fix included
29 > 42 mm 1.14" > 1.65"	5,7 cm 2.24"	Fix included
43 > 56 mm 1.69" > 2.20"	7,1 cm 2.80"	Fix included

Fix Foot

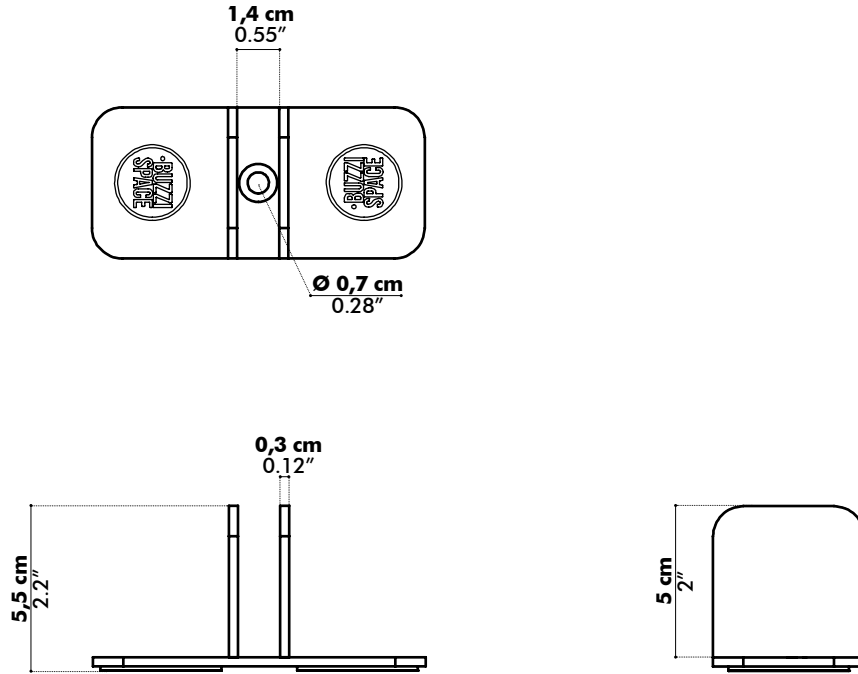

Split Fix

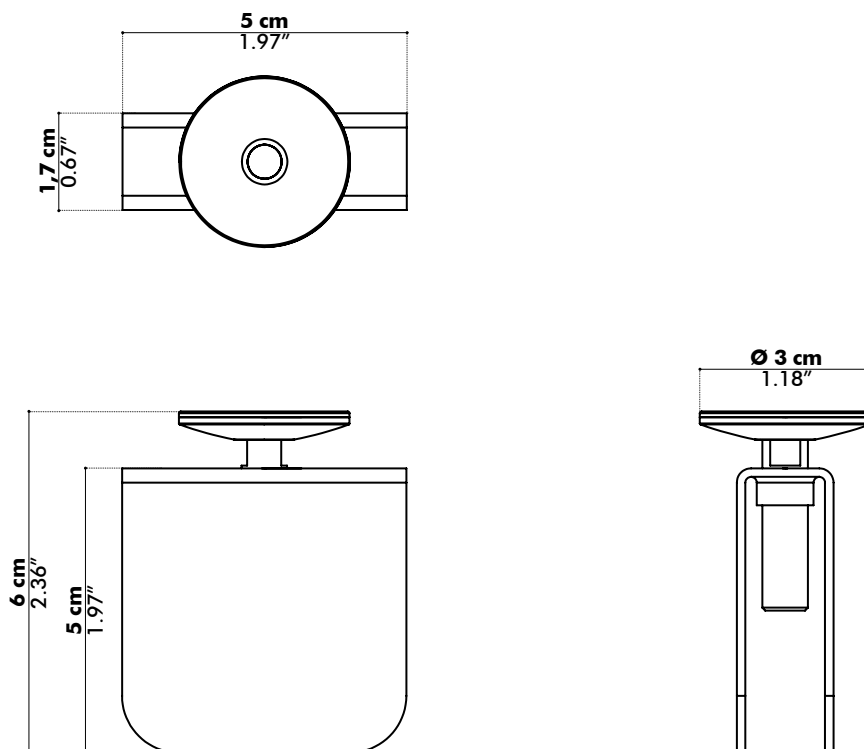

Acoustics

BuzziTripl Desk Split

Equivalent sound absorption area in m² per object

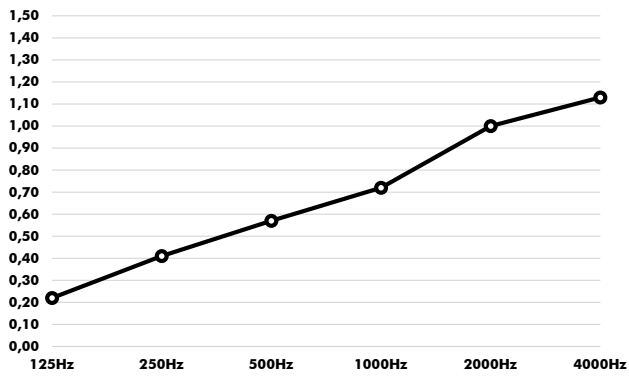

Hz	Aeq/m ²
125	0,22
250	0,41
500	0,57
1000	0,72
2000	1
4000	1,13