BuzziTube

Product Specification Sheet

This document contains technical information about the BuzziTube



www.buzzi.space









Create different atmospheres

BuzziTube's voluminous geometric design finds a perfect balance between a suspended acoustic ceiling panel and a work of art. Due to its 3-dimensional, yet soft and delicate look, BuzziTube instantly elevates any modern residential or commercial space while absorbing excessive noise.

The acoustic solution can be used as a standalone or combined with our BuzziJet family or any pre-existing lighting units to create a dynamic touch in any open space. BuzziTube arrives in four different models (S/M/L/XL) and can be upholstered in a wide range of fabrics and colors, making it easy to suit your needs. Additionally, the cable is colored in either a discreet black or alu, so it will not overpower any pre-existing design.

Design by BuzziSpace Studio

General

-  Ceiling Suspended
S | M | L | XL
-  Upholstered acoustic foam element
Powder coated metal frame in white (RAL 9010)
Cover: Fabric, Trevira CS+ | CS, Revive 1, Clara 2, Remix 3, Hero, Tonus 4, Memory 2
-  Dry Use
-  Assembled
-  Ceiling Suspended Straight or Split (only available for BuzziTube S | M)
3x black or alu cables 2 - 5 m | 78.74" – 196.85"
-  If Installing on suspended ceiling, verify load capacity prior to installation.

Certifications



Acoustics



Absorption



Diffusion



Low Tone



Mid Tone



High Tone

Content

| | |
|----------------|----|
| Configurations | 3 |
| Mounting | 5 |
| Fabrics | 6 |
| Dimensions | 9 |
| Acoustics | 13 |

Configuration

BuzziTube S

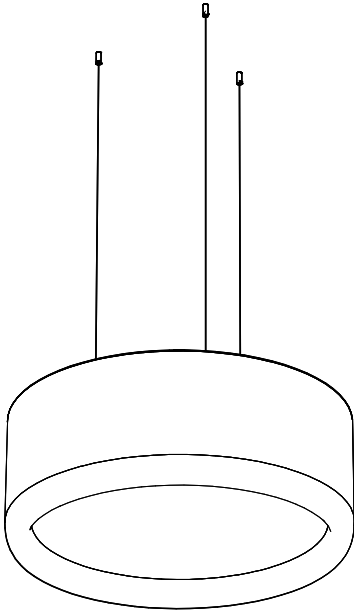

📍 Ceiling Suspended

Upholstered acoustic foam element

🌲 Powder coated metal frame in white (RAL 9010)

Cover: Fabric, Trevira CS+ | CS, Revive 1, Clara 2, Remix 3, Hero, Tonus 4, Memory 2

✂️ Ø 80 cm H: 22,5 cm
Ø 31.50" H: 8.86"

⚖️ 5,7 kg | 12.57 lbs

⋯ Ceiling Suspended Straight or Split
3x black or alu cables 2 - 5 m | 78.74" – 196.85"

⚠️ If Installing on suspended ceiling, verify load capacity prior to installation.

BuzziTube M

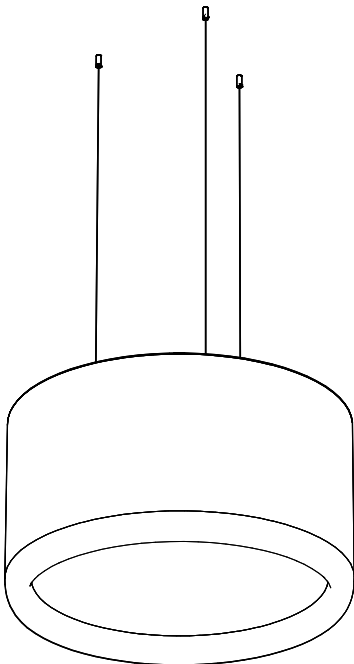

📍 Ceiling Suspended

Upholstered acoustic foam element

🌲 Powder coated metal frame in white (RAL 9010)

Cover: Fabric, Trevira CS+ | CS, Revive 1, Clara 2, Remix 3, Hero, Tonus 4, Memory 2

✂️ Ø 80 cm H: 45 cm
Ø 31.50" H: 17.72"

⚖️ 6,8 kg | 14.99 lbs

⋯ Ceiling Suspended Straight or Split
3x black or alu cables 2 - 5 m | 78.74" – 196.85"

⚠️ If Installing on suspended ceiling, verify load capacity prior to installation.

BuzziTube L

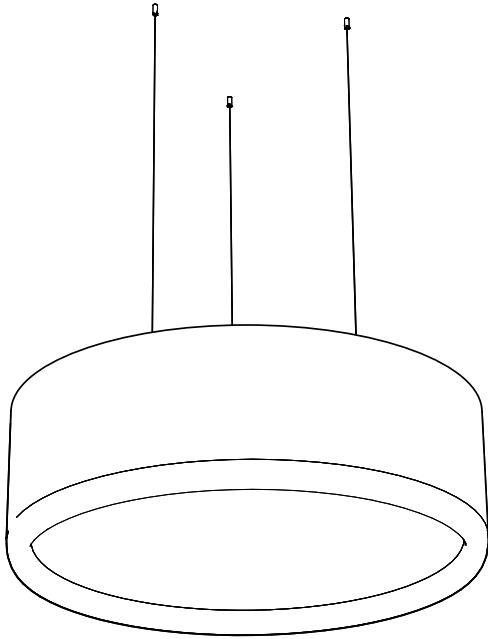

🔑 Ceiling Suspended

Upholstered acoustic foam element

🌲 Powder coated metal frame in white (RAL 9010)
Cover: Fabric, Trevira CS+ | CS, Revive 1, Clara 2, Remix 3, Hero, Tonus 4, Memory 2

✂️ Ø 120 cm H: 40 cm
Ø 47.2" H: 15.75"

⚖️ 11 kg | 24.25 lbs

⋯ Ceiling Suspended Straight
3x black or alu cables 2 - 5 m | 78.74" – 196.85"

⚠️ If Installing on suspended ceiling, verify load capacity prior to installation.

BuzziTube XL

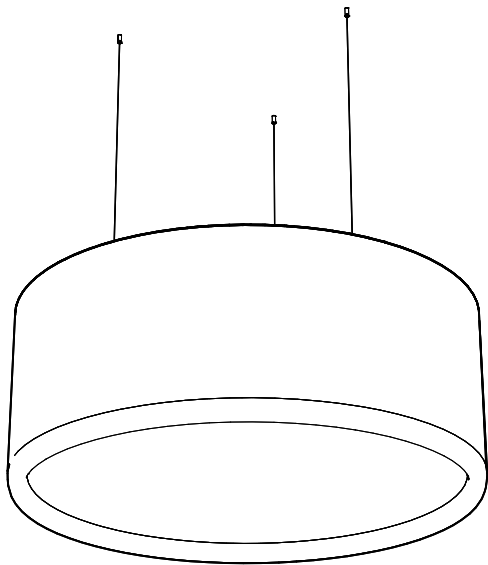

🔑 Ceiling Suspended

Upholstered acoustic foam element

🌲 Powder coated metal frame in white (RAL 9010)
Cover: Fabric, Trevira CS+ | CS, Revive 1, Clara 2, Remix 3, Hero, Tonus 4, Memory 2

✂️ Ø 120 cm H: 52,5 cm
Ø 47.24" H: 20.67"

⚖️ 13 kg | 28.66 lbs

⋯ Ceiling Suspended Straight
3x black or alu cables 2 - 5 m | 78.74" – 196.85"

⚠️ If Installing on suspended ceiling, verify load capacity prior to installation.

Mounting

Ceiling Suspended Straight

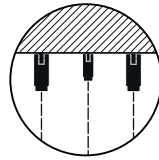
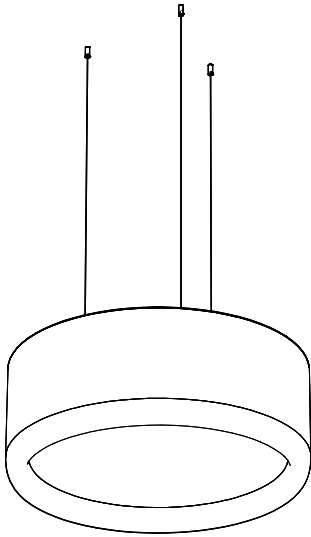

Ceiling Suspended Straight
Fixing System Screw with 3 cables of
2 - 5 m | 78.74" – 196.85" (black or alu)
Min. distance of shade to ceiling is 10 cm | 3.94"

Ceiling Suspended Split (only available for BuzziTube S | M)

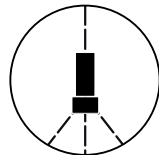
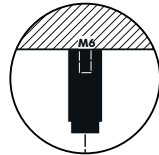
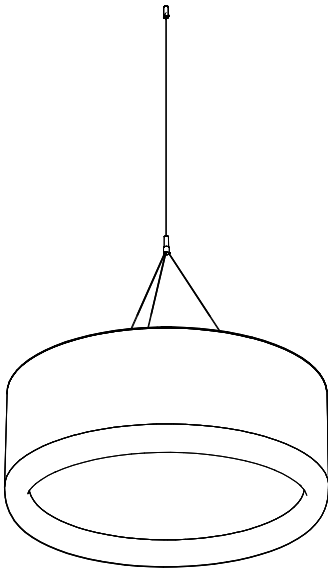

Ceiling Suspended Split
Fixing System Screw with 3 split cables and 1 main
cable, total length of 2 - 5 m | 78.74" – 196.85"
(black or alu)
Min. distance of shade to ceiling is 50 cm | 19.69"

Fabrics

Fabric

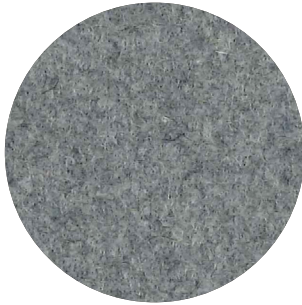

Category A

Composition 70% Recycled Wool, 25% Recycled Polyacryl,
5% Recycled Other Fabrics

Weight 405 g/m² | 11.94 oz/yd²

Abrasion resistance 40.000 Martindale, 50,000 Wyzenbeek

Flammability EU: EN 1021.1/2006 | BS EN 1021.1/2006 (cigarette).
EN 1021.2/2006 | BS EN 1021.2/2006 (match)
USA: CAL TB 117 | ASTM E84 CLASS A

Fastness to light EU: 4 | USA 4

Fastness to rubbing EU: Wet 3-4 | Dry 4-5

Fastness to crocking USA: Wet 5 | Dry 5



Trevira CS+ | CS

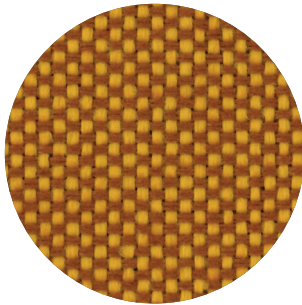

Category A

Weight 420 g/m² | 12.39 oz/yd²

Composition 100% Polyester, Trevira CS

Abrasion resistance 100.000 Martindale, 90,000 Wyzenbeek

Flammability BS 5852 part II: CRIB 5 | BS 7176 Medium Hazard
USA: CAL TB 117 | M1 | B1 | EN 1021/1-2 | C1 |
IMO Res. A652 (16)

Fastness to light EU: 6 | USA 5

Fastness to rubbing EU: Wet 4-5 | Dry 4-5

Fastness to crocking USA: Wet 5 | Dry 5



Revive 1

kvadrat

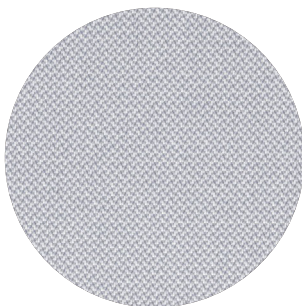

Category A

Composition 100% recycled polyester FR

Weight 430 g/lin.m

Abrasion resistance 60.000 Martindale rubs, EN ISO 12947

Flammability EN 1021-1/2 | DIN 4102 B1 | Önorm B1/Q1
UNI 9175 1IM | US Cal. Tech. Bull. 117
IMO A.652 (16)

Fastness to light Note 5-7, ISO 105-B02

Fastness to rubbing (ISO) dry 5, wet 4-5

Pilling Note 4-5, EN ISO 12945



Clara 2

kvadrat

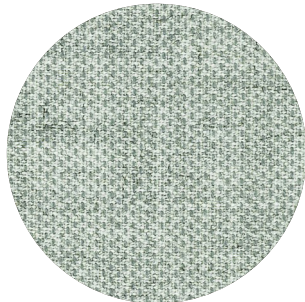

Category B

Composition 92% new wool, 8% nylon

Weight 400 g/lin.m

Abrasion resistance 80.000 Martindale rubs, EN ISO 12947

Flammability EN 1021-1/2 | BS 5852, ignition source 2-3 | DIN 4102 B2
NF D 60 013 | UNI 9175 11M | US Cal. Tech. Bull. 117, Sec. E
NFPA 260 | IMO A.652(16)

Fastness to light Note 5-7, ISO 105-B02

Fastness to rubbing (ISO) dry 4-5, wet 4

Pilling Note 4, EN ISO 12945



Remix 3

kvadrat



Category B

Composition 90% new wool, 10% nylon

Weight 415 g/lin.m

Abrasion resistance 100.000 Martindale rubs, EN ISO 12947

Flammability EN 1021-1/2 | BS 5852 part 1
Önorm B1/Q1 | NF D 60 013 | UNI 9175, 11M
AS/NZS 1530.3 | Cal. Tech. Bull. 117-2013
NFPA 260 | IMO FTP Code 2010:Part 8

Fastness to light Note 5-7, ISO 105-B02

Fastness to rubbing (ISO) dry 4-5, wet 4

Pilling Note 4, EN ISO 12945



Hero

kvadrat

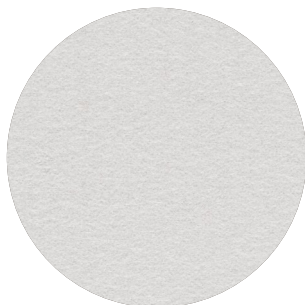

Category C

Composition 96% new wool, 4% nylon

Weight 580 g/lin.m

Abrasion resistance 45.000 Martindale rubs, EN ISO 12947

Flammability EN 1021-1/2 | DIN 4102 B2 | NF D 60 013
UNI 9175 11M | US Cal. Bull. 117-2013 | NFPA 260
IMO A.652 (16)

Fastness to light Note 5-6, ISO 105-B02

Fastness to rubbing (ISO) dry 4-5, wet 4-5

Pilling Note 3-4, EN ISO 12945



Tonus 4

kvadrat



Category D

Composition 90% new wool, 10% Helanca

Weight 665 g/lin.m

Abrasion resistance 100.000 Martindale rubs, EN ISO 12947

Flammability EN 1021-1/2 | BS 5852 part 1 | DIN 4102 B2

Önorm B1/Q1 | NF D 60 013 | UNI 9175 11M

US Cal. Bull. 117-2013 | NFPA 260 | IMO A.652 (16)

Fastness to light Note 5-7, ISO 105-B02

Fastness to rubbing (ISO) dry 3-5, wet 3-5

Pilling Note 3, EN ISO 12945



Memory 2

kvadrat

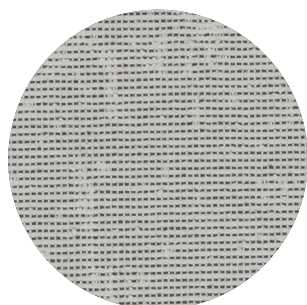

Category E

Composition 100% Trevira CS

Weight 700 g/lin.m

Abrasion resistance

35.000 rubs acc. to the Martindale method, EN ISO 12947

Flammability EN 1021-1/2 | DIN 4102 B1 | Önorm B1/Q1

NF D 60 013 | NF P 92 507 M1 | UNI 9175 11M

UNI 9177 classe 1 | US Cal. Tech. Bull. 117

IMO A.652 (16)

Fastness to light Note 5-8, ISO 105-B02

Fastness to rubbing (ISO) dry 4-5, wet 4-5

Pilling Note 4, EN ISO 12945



Dimensions

BuzziTube S

Straight

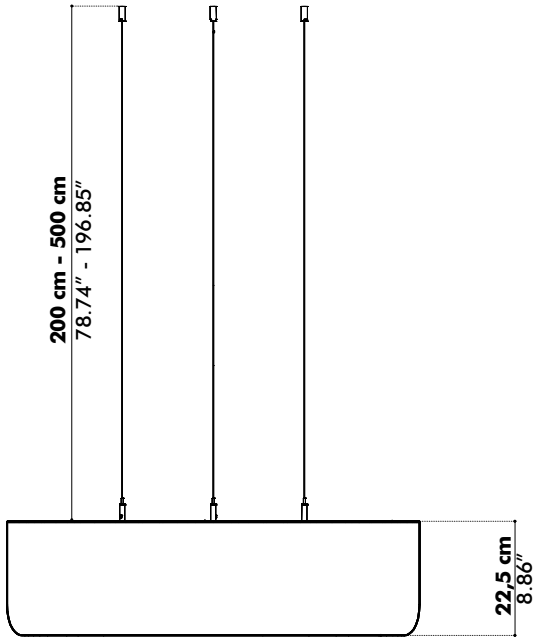

Split

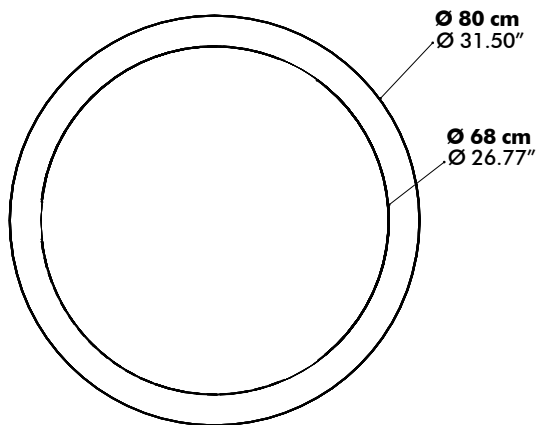
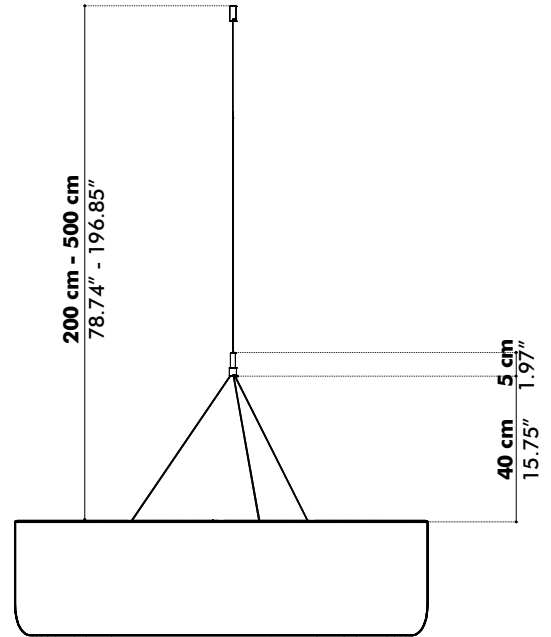

BuzziTube M

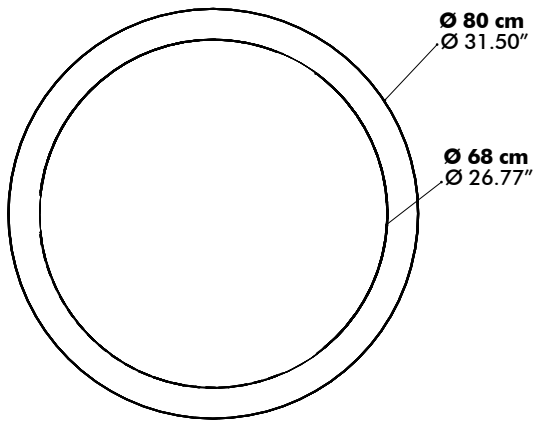
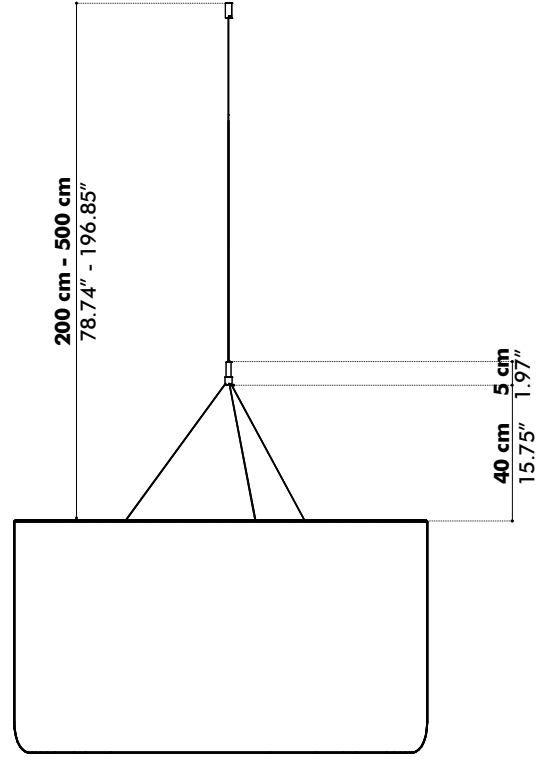
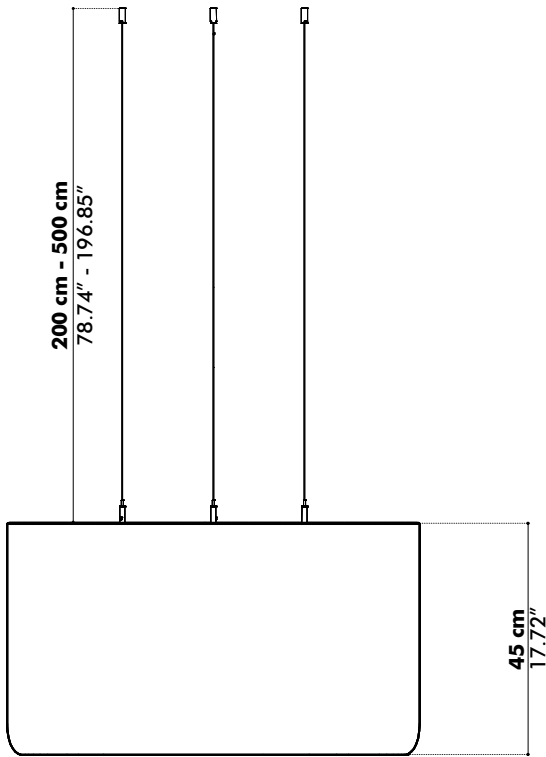

BuzziTube L

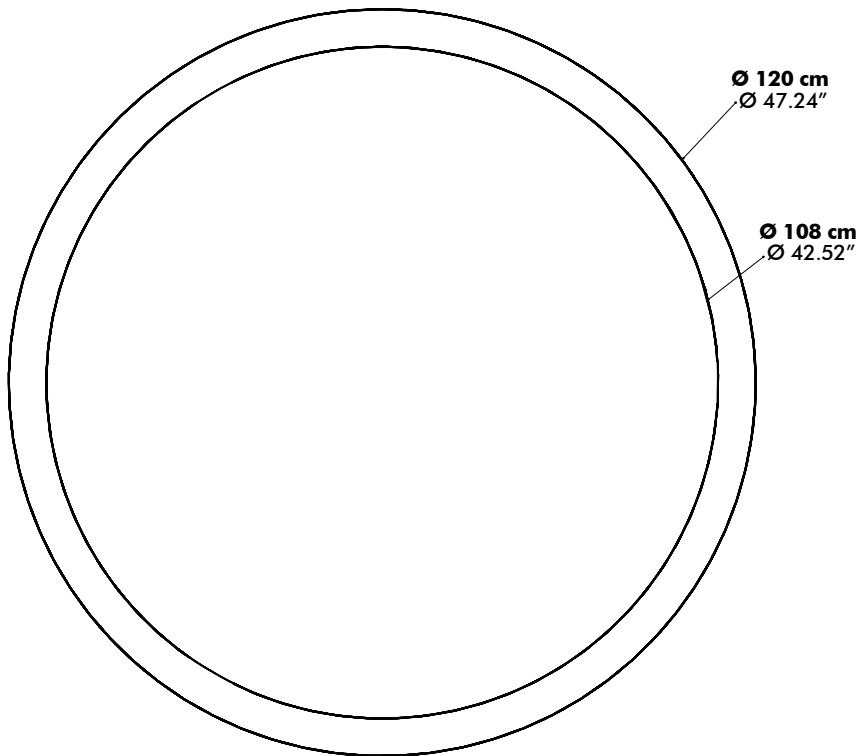
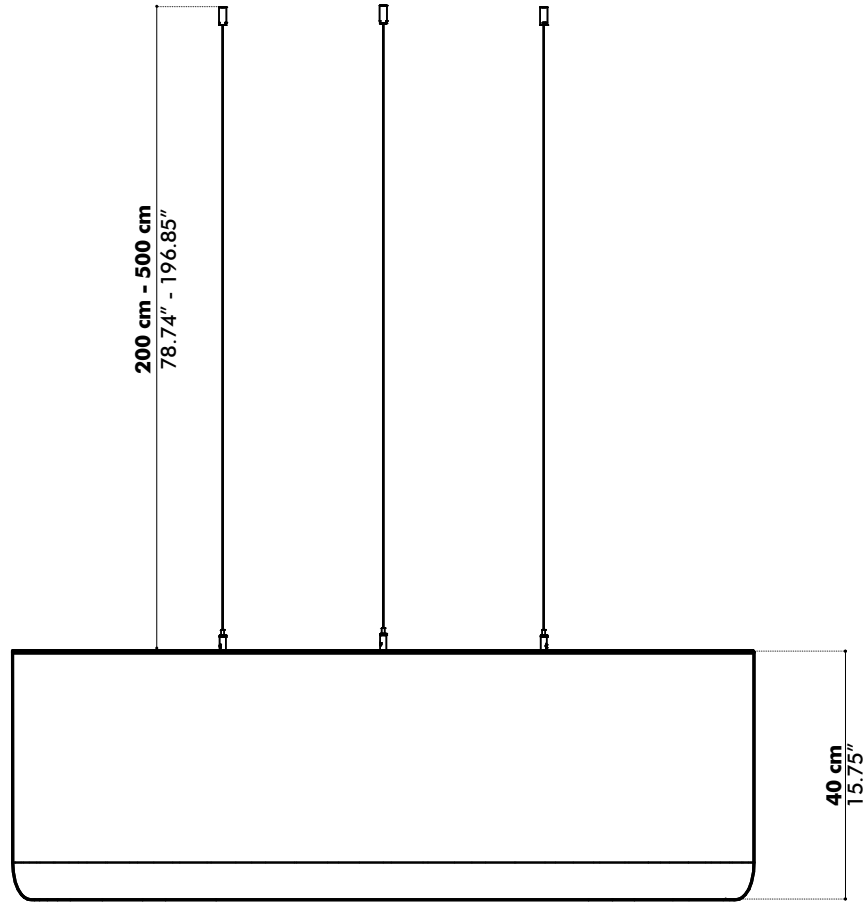

BuzziTube XL

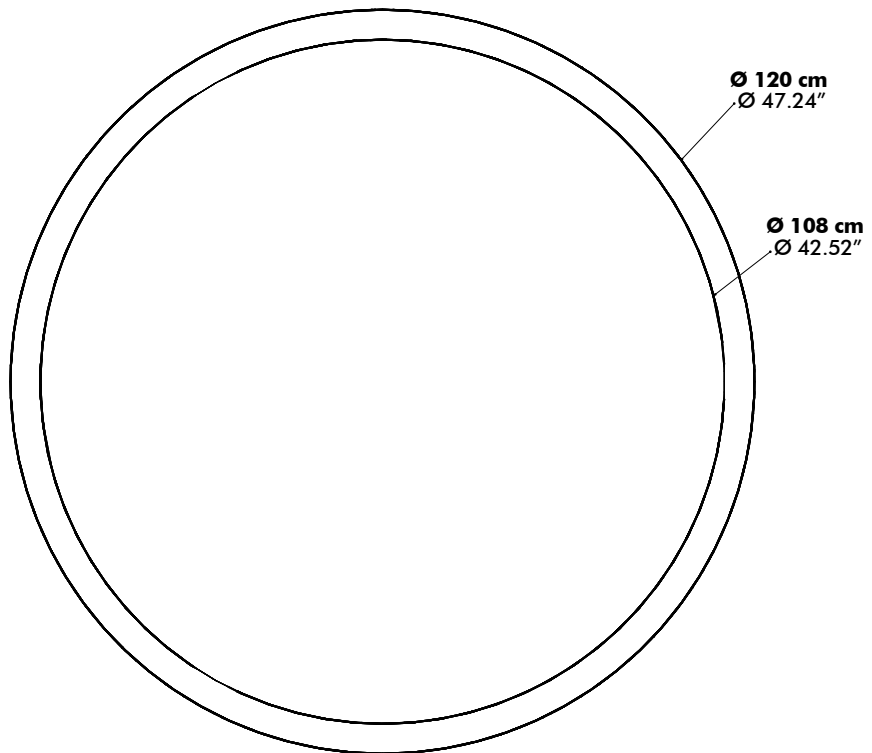
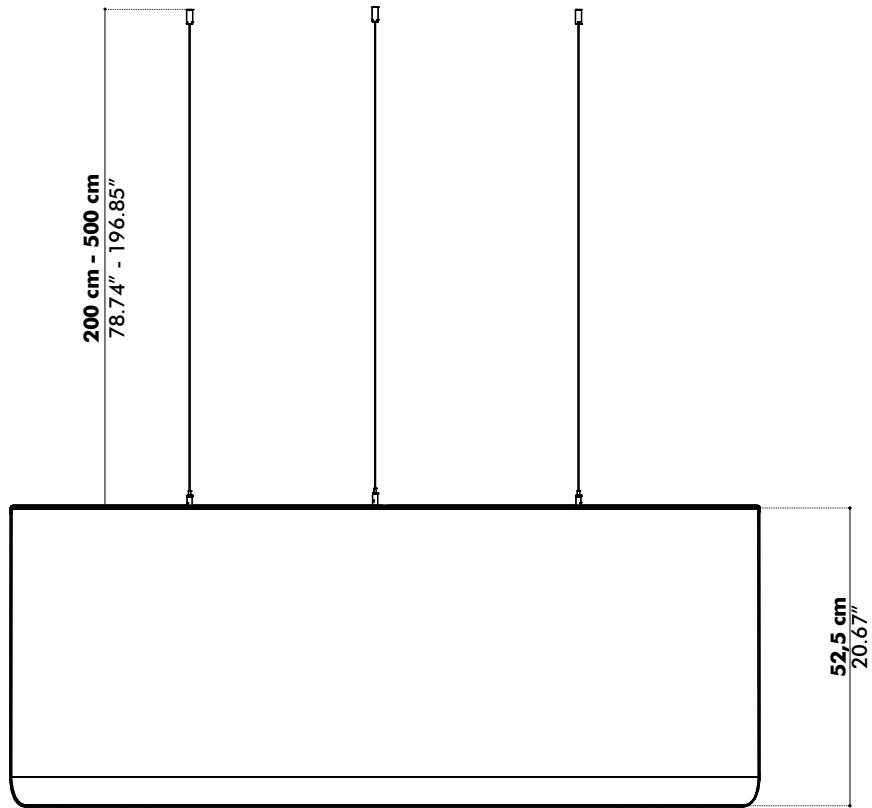

Acoustics

BuzziTube

Equivalent sound absorption area in m² per object

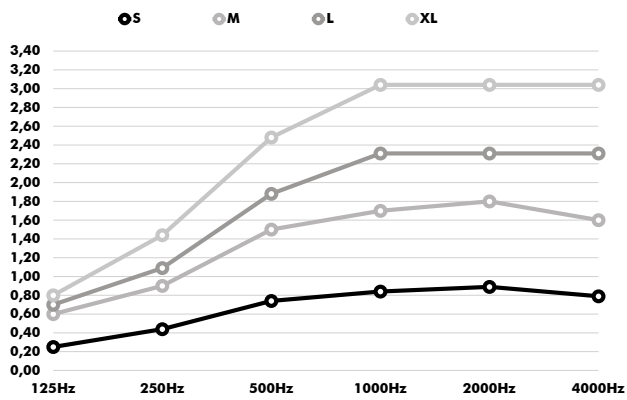

| Hz | S Aeq/m ² | M Aeq/m ² | L Aeq/m ² | XL Aeq/m ² |
|------|----------------------|----------------------|----------------------|-----------------------|
| 125 | 0.25 | 0.60 | 0.70 | 0.80 |
| 250 | 0.44 | 0.90 | 1.09 | 1.44 |
| 500 | 0.74 | 1.50 | 1.88 | 2.48 |
| 1000 | 0.84 | 1.70 | 2.31 | 3.04 |
| 2000 | 0.89 | 1.80 | 2.31 | 3.04 |
| 4000 | 0.79 | 1.60 | 2.31 | 3.04 |