BuzziBracks

Product Specification Sheet

This document contains technical information about the BuzziBracks



www.buzzi.space

A room within a room... with a view

BuzziBracks found its way to the drawing board to answer the need for flexible, new ways of working. In open spaces, this modular unit system can be combined in numerous ways to create different areas – to work, focus, relax or meet. The curtains, available in a wide color palette, act as a visual as well as acoustic shield from the surroundings, separating one zone from the other. Combine transparent with non-transparent curtains and open or close them as needed for privacy. Be your own architect and continuously create and recreate microenvironments within open workspaces.

Design by Alain Gilles

General

 Bracks Medium | High | Extra High

Frame powder coated metal in beige red (RAL 3012), black (RAL 9005), black green (RAL 6012), light green (RAL 6027), pastel blue (RAL 5024), pastel green (6019) or signal grey (RAL 7004)

 Curtain in Cur A, B, C, D or F

Surface Worktops and shelves in Antwerp Oak or White Laminate, metal support in powder coated metal (same color as frame)

 Dry use

Shelves

... Worktop

Accessoires

Electrification

Acoustics



Attenuation



Diffusion



Absorption



Low tones



Mid tones



High tones

Content

Configurations	3
Add-ons	5
Electrification	9
Curtains	12
Finishes	15
Dimensions	16
Acoustics	23

Configurations

Medium

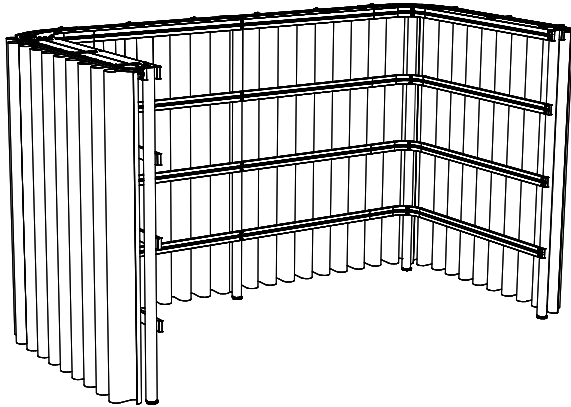

Frame powder coated metal in beige red (RAL 3012), black (RAL 9005), black green (RAL 6012), light green (RAL 6027), pastel blue (RAL 5024), pastel green (6019) or signal grey (RAL 7004)



Curtain in Cur A, B, C, D or F

Worktops and shelves in Antwerp Oak or White Laminate, metal support in powder coated metal (same color as frame)

H: 151 cm

D: 120 cm or 150 cm

W: 160 cm or 240 cm



H: 59.45"

D: 47.24" or 59.06"

W: 62.99" or 94.49"

Cover

Shelves



Worktop

Accessoires

Electrification

High

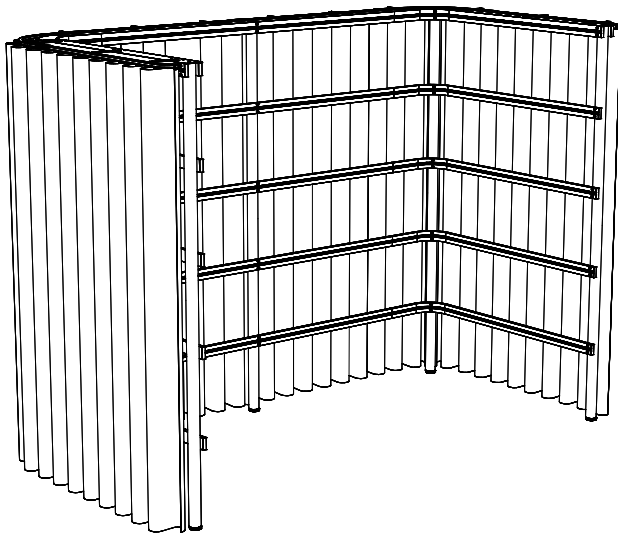

Frame powder coated metal in beige red (RAL 3012), black (RAL 9005), black green (RAL 6012), light green (RAL 6027), pastel blue (RAL 5024), pastel green (6019) or signal grey (RAL 7004)



Curtain in Cur A, B, C, D or F

Worktops and shelves in Antwerp Oak or White Laminate, metal support in powder coated metal (same color as frame)

H: 188,5 cm

D: 120 cm or 150 cm

W: 160 cm, 240 cm or 320 cm



H: 74.21"

D: 47.24" or 59.06"

W: 62.99", 94.49" or 126"

Cover

Shelves



Worktop

Accessoires

Electrification

Extra High

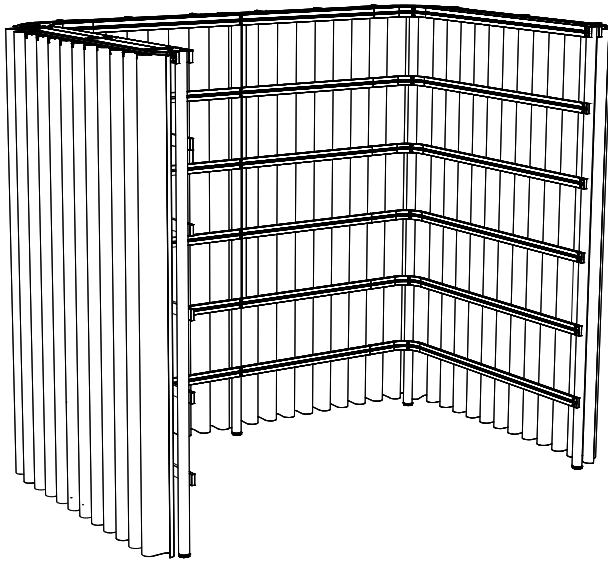

Frame powder coated metal in beige red (RAL 3012), black (RAL 9005), black green (RAL 6012), light green (RAL 6027), pastel blue (RAL 5024), pastel green (6019) or signal grey (RAL 7004)



Curtain in Cur A, B, C, D or F

Worktops and shelves in Antwerp Oak or White Laminate, metal support in powder coated metal (same color as frame)

H: 226 cm

D: 150 cm

W: 160 cm, 240 cm or 320 cm



H: 89.97"

D: 59.06"

W: 62.99", 94.49" or 126"

Shelves

Worktop



Accessoires

Electrification

Add-ons

Shelf Full

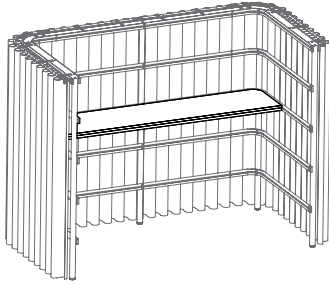

Surface: Antwerp Oak or White Laminate
Metal support: same color as frame
Available for width: 160 cm or 240 cm
62.99" or 94.49"

Shelf A

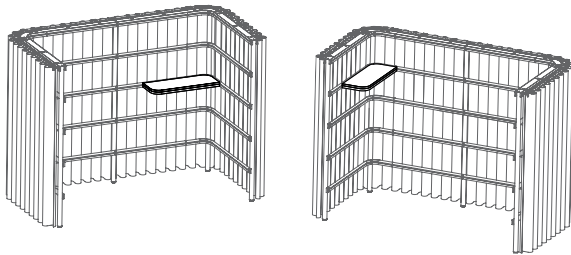

Surface: Antwerp Oak or White Laminate
Metal support: same color as frame
Left or Right side position

Shelf B

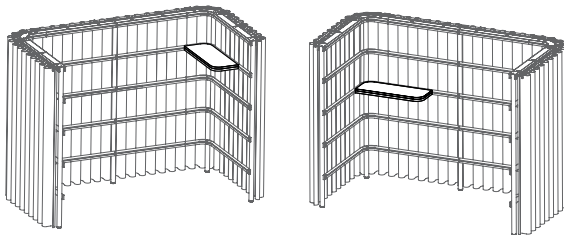

Surface: Antwerp Oak or White Laminate
Metal support: same color as frame
Left or Right side position

Worktop Full

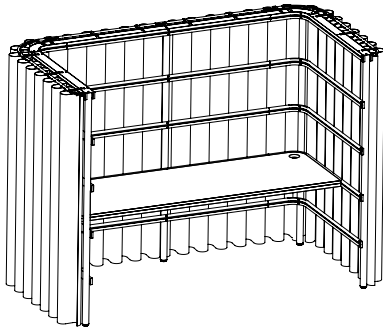

Surface: Antwerp Oak or White Laminate
Metal support: same color as frame
Optional: 2 cutouts for electrification
Ø 80 mm | 3.15"
Available for width: 160 cm or 240 cm
62.99" or 94.49"

Worktop A

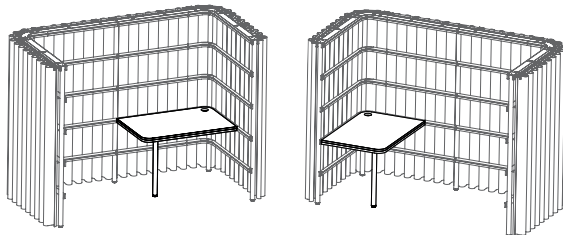

Surface: Antwerp Oak or White Laminate
Metal support: same color as frame
Left or Right side position
Optional: 1 cutout for electrification
Ø 80 mm | 3.15"
Available for depth: 120 cm or 150 cm
47.24" or 59.06"

Worktop B

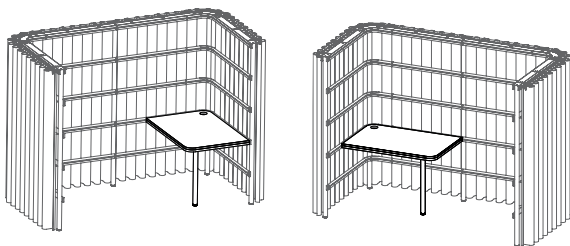

Surface: Antwerp Oak or White Laminate
Metal support: same color as frame
Left or Right side position
Optional: 1 cutout for electrification
Ø 80 mm | 3.15"
Available for depth: 120 cm or 150 cm
47.24" or 59.06"

Meet

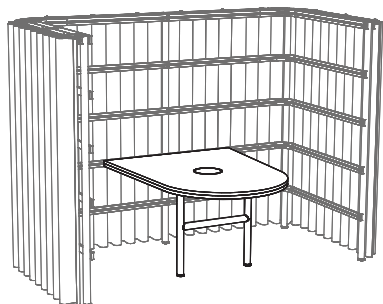

Medium | Large
Adjustable height: 75,5 cm or 113 cm
29.72" or 44.49"
Metal support: same color as frame
Optional: 1 cutout for electrification
Ø 22 cm | 8.66"

Cover

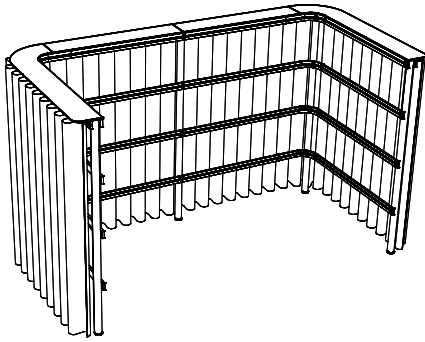

Finishing metal cover in black or same color as frame
H 6 cm (including 3 mm coverplate)
D 130 cm | 160 cm
W 180 cm | 260 cm | 340 cm

H 2.36" (including 0.12" coverplate)
D 51.18" | 62.99"
W 70.87" | 102.36" | 133.86"

Pinboard Buzzifelt

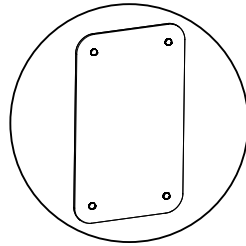
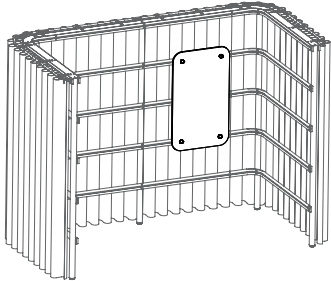

BuzziFelt
Metal screw
Horizontal and vertical position
Optional bicolor
W 54,5 cm H 92 cm D 1,2 cm
W 21.46" H 36.22" D 0.47"

Hooks

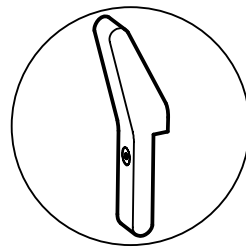
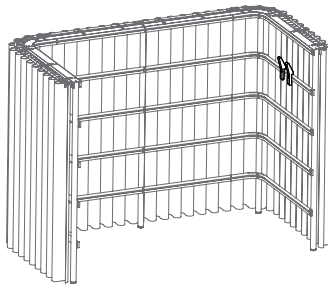

Antwerp Oak
Black screw
W 3,5 cm H 21 cm D 6 cm
W 1.38" H 8.27 " D 2.36"

Universal Mount

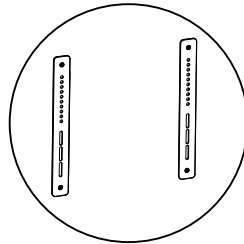
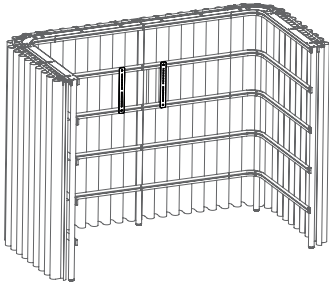

Finishing metal in black or same color as frame

W 5 cm H 42,5 cm D 0,4 cm

W 1.97" H 16.73" D 0.16"

Maximum weight: 20 kg | 45lbs

Requirements to meet max. weight:

Load has to be directly attached to the frame.

Telescopic brackets for displays will limit weight due to leverage effect

Minimum 4 connection points / screws

Screws need to be positioned at least 20 cm | 8 inch from each other

Flag

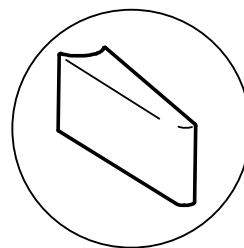
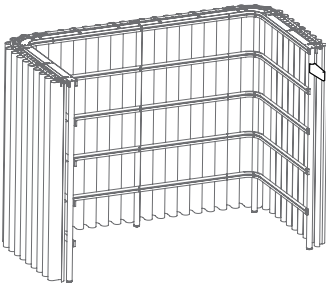

Antwerp Oak

Mounted with a magnet to the frame

W 25 cm H 6 cm D 5 cm

W 9.84" H 2.36" D 1.97"

Electrification (optional)

Select your optional electrification set in line with the cutout in your worktop

Netbox Point Single

Optional for all worktops with a
 \varnothing 8 cm | 3.15" cutout

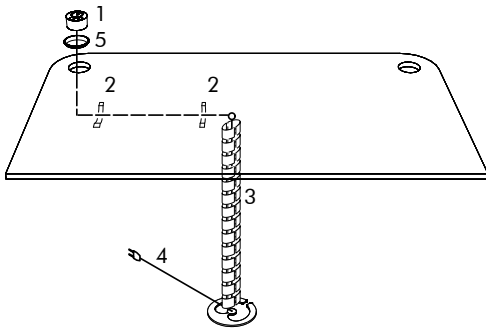

- | | |
|---|----|
| 1. Electrification Unit
(Incl. Power Cable 2,9 m 114.17" Cable length) | 1x |
| 2. Horizontal Cable Clips | 2x |
| 3. Vertical Cable Manager | 1x |
| 4. Power Cable (3 m 118.11" Cable length) | 1x |
| 5. Cable entry cover | 1x |

* Can be ordered excl. wire management

Netbox Point Double

Optional for worktops with
 2 x \varnothing 80 mm | 3.15" cutout

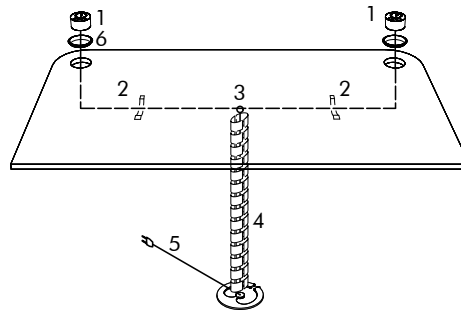

- | | |
|--|----|
| 1. Electrification Unit (2x 1,4 m 55.12" Cable length) | 2x |
| 2. Horizontal Cable Clips | 2x |
| 3. Central Connection Block | 1x |
| 4. Vertical Cable Manager | 1x |
| 5. Power Cable (3 m 118.11" Cable length) | 1x |
| 6. Cable entry cover | 1x |

Cable Box Single

Optional for all Meet with a
 \varnothing 22 cm | 8.66" cutout

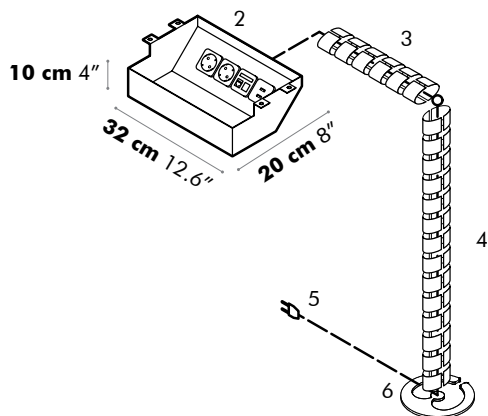

- | | |
|-----------------------------|----|
| 1. Cable entry cover | 1x |
| 2. Electrification Unit | 1x |
| 3. Horizontal Cable Manager | 1x |
| 4. Vertical Cable Manager | 1x |
| 5. Cable entry cover | 1x |
| 6. Thermal fuse (US only) | 1x |

Electrification Unit

An electrification unit can be ordered for different regions.

Each electrification unit includes a HDMI, DATA and USB module. It can be configured (by the customer) by snapping HDMI, DATA and/or USB 2.0 (not charging) in the grey zone.

F  NL|DE|LUX

E  BE|FR

G  UK

B  US

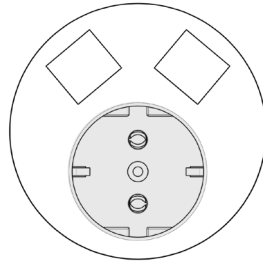

 HDMI

 DATA

 USB

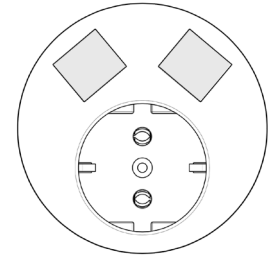

Cable entry cover

Available in black or alu

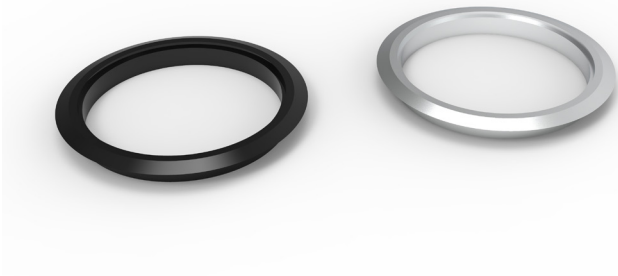

Horizontal Cable Clips

Color Grey
Can guide up to 8 cables 3G1,5

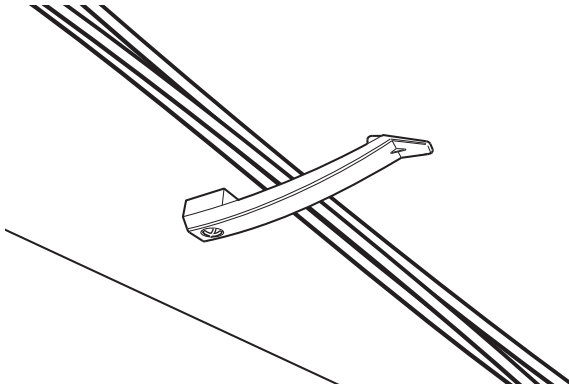

Vertical Cable Manager

Color: Black
Set for Worktop H 75 cm | 29.53": 16 chains
Set for Worktop H 108 cm | 42.52": 27 chains

- 1 set includes:
vertical cable runs, baseplate, table attachment,
screw set
- Capacity up to ± 40 cables
- Material polypropylen (cable runs)
painted steel (baseplate)
- 2 chamber system
- Cables using the easy zip principle

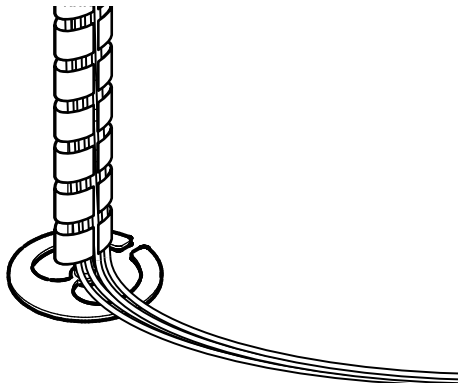

Curtains

Frost

kvadrat

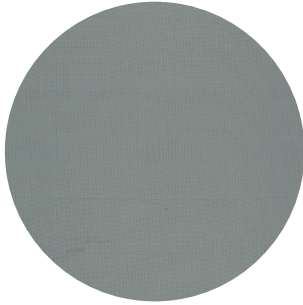

Cur A

Composition 50% polyester FR, 50% polyester

Weight App. 150 g/lin.m

Flammability EN 13 773 class 1 | BS 5867 part 2 type B | DIN 4102 B1
SN 198 898 5.2 | NF D 92 507 M1 | UNI 9177 classe1
NFPA 701 | AS/NZS 1530.3 | IMO A.471 (XII)

Fastness to light Note 5-7, ISO 105-B02

Maintenance Washable at max. 30°C - 90°F. Drip drying. Ironing will be necessary.

Daybreak 2

kvadrat

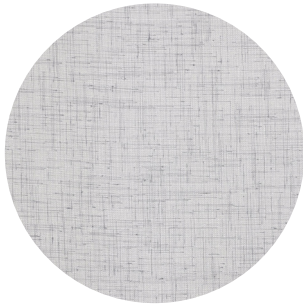

Cur B

Composition 100% polyester FR

Weight App. 270 g/lin.m

Flammability EN 13 773 class 1 | BS 5867 part 2 type B | DIN 4102 B1
SN 198 898 5.2 | NF D 92 507 M1 | UNI 9177 classe 1
AS/NZS 1530.3 | IMO A.471 (XII)

Fastness to light Note 5-7, ISO 105-B02

Maintenance Washable at max. 30°C - 90°F. Drip drying. Ironing will be necessary.

BuzziVelvet



Cur B

Composition 100% PES

Weight 375 g/m² | 11.06 oz/yd²

Width 140 cm | 55.12"

Thickness 0,7mm | 0.0275"

Abrasion resistance >100.000 Martindale

Flammability USA: CAL TB 117

Fastness to light EU: 4-5

Fastness to rubbing EU: Wet 4 | Dry 4-5

Pilling EU: 4-5

Match Weight ±5% | Width ±2%

Maintenance Vacuum clean regularly. Don't wash. Don't remove the Velvet from the product. Treat spillages immediately. Professional dry clean or wipe clean with a pH neutral soap and a damp cloth.

Dawn 2

kvadrat

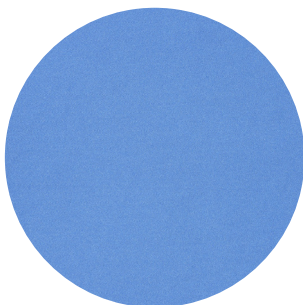

Cur C

Composition 100% polyester FR

Weight App. 780 g/lin.m

Flammability EN 13 773 class 1 | EN 13501, B-s1, d0 | BS 5867 part 2
type B | DIN 4102 B1 | SN 198 898 5.2 | NF D 92 507 M1 |
UNI 9177 classe 1

Fastness to light Note 5-7, ISO 105-B02

Maintenance Washable at max. 30°C - 90°F. Half wash load. Drip drying.
Ironing might be necessary when washed at 30°C - 90°F.

Zulu 2

kvadrat

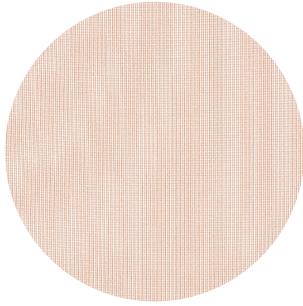

Cur C

Composition 100 % Trevira CS

Weight App. 300 g/lin.m

Flammability EN 13 773 class 1 | BS 5867 part 2 | DIN 4102 B1 | NF P 92 507 M1 | UNI 9177 classe 1 | IMO FTP Code 2010:Part 7

Fastness to light Note 7, ISO 105-B02

Maintenance Wash at 30°C - 90°F. Drip drying.

Drops

kvadrat

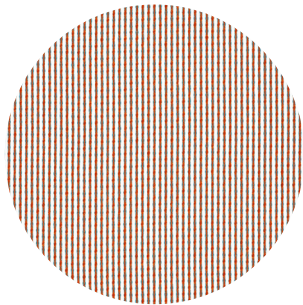

Cur D

Composition 100 % Trevira CS

Weight App. 225 g/lin.m

Flammability EN 13 773 class 1 | BS 5867 part 2 type B | DIN 4102 B1
NF D 92 507 M1 | UNI 9177 classe 1 | FAR 25.853 | IMO FTP
Code 2010:Part 7

Fastness to light Note 6-7, ISO 105-B02

Maintenance Washable at max. 30°C - 90°F. Drip drying.

Mi Casa

kvadrat

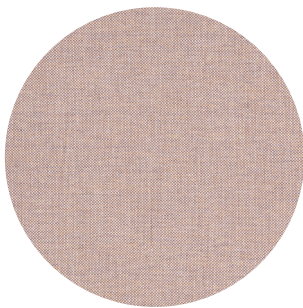

Cur D

Composition 100% Trevira CS

Weight App. 600 g/lin.m

Flammability EN 13 773 class 1 | BS 5867 part 2 type B | DIN 4102 B1
SN 198 898 5.2 | NF D 92 507 M1 | UNI 9177 classe 1
IMO FTP Code 2010:Part 7

Fastness to light Note 5-7, ISO 105-B02

Maintenance Washable at max. 30°C - 90°F. Half wash load. Drip drying.
Ironing might be necessary when washed at 30°C - 90°F.

Drops Acoustic

kvadrat

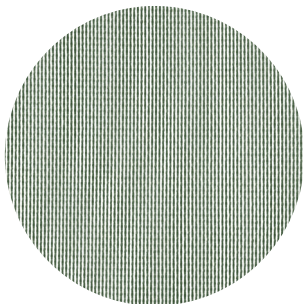

Cur F

Composition 100% Trevira CS

Weight App. 315 g/lin.m

Flammability BS 5867 part 2 type B | DIN 4102 B1 | EN 13773 Class 1
IMO FTP Code 2010:Part 7 | NF P 92 507 M1 | SN 198 898 5.2
UNI 9177 classe 1

Fastness to light Note 7 ISO 105-B02

Maintenance Washable at max. 30°C - 90°F. Drip drying.



Cur F

Composition 100% recycled polyester FR

Weight App. 660/lin.m

Flammability BS 5867 part 2 type B | DIN 4102 B1 | UNI 9177 classe 1
IMO FTP Code 2010:Part 7

Fastness to light Note 6-7, ISO 105-B02

Maintenance Washable at max. 30°C - 90°F. Half wash load. Drip drying.
Ironing might be necessary when washed at 30°C - 90°F.

Curtain 2 pcs, symmetric

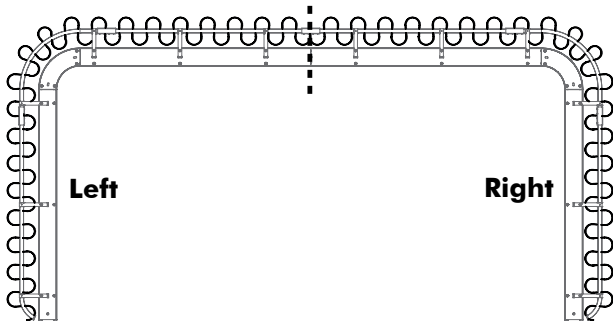

Left + Right

Curtains Left and Right can be chosen in a different curtain collection and color.

Curtain 2 pcs, asymmetric

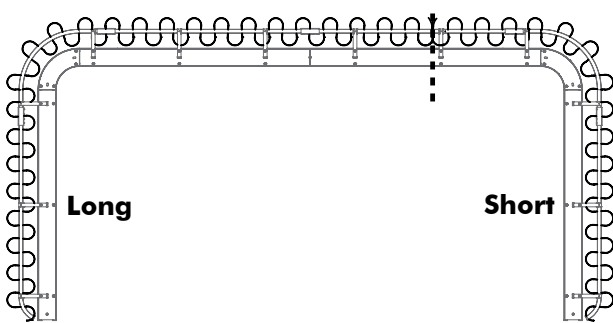

Long + Short

Curtains Long and Short can be chosen in a different curtain collection and color.

Finishes

Frame colors

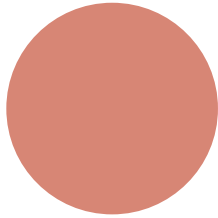

beige red
(RAL 3012)

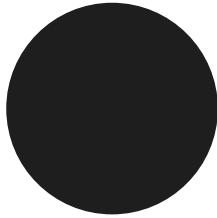

black
(RAL 9005)

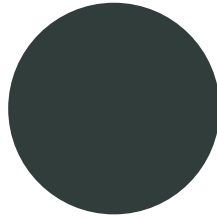

black green
(RAL 6012)

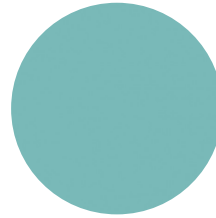

light green
(RAL 6027)

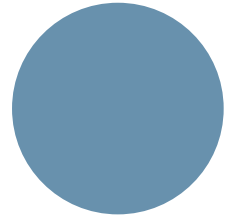

pastel blue
(RAL 5024)

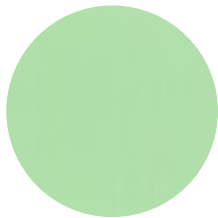

pastel green
(RAL 6019)

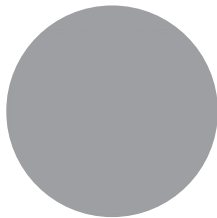

signal grey
(RAL 7004)

Worktops and Shelves



Antwerp Oak*



White Laminate with
plywood core and
oiled edges

*These solid wood worktops may contain knots, natural color variations and drying splits as normal features of the product. This contributes to the uniqueness of each worktop.

Dimensions

Bracks Medium

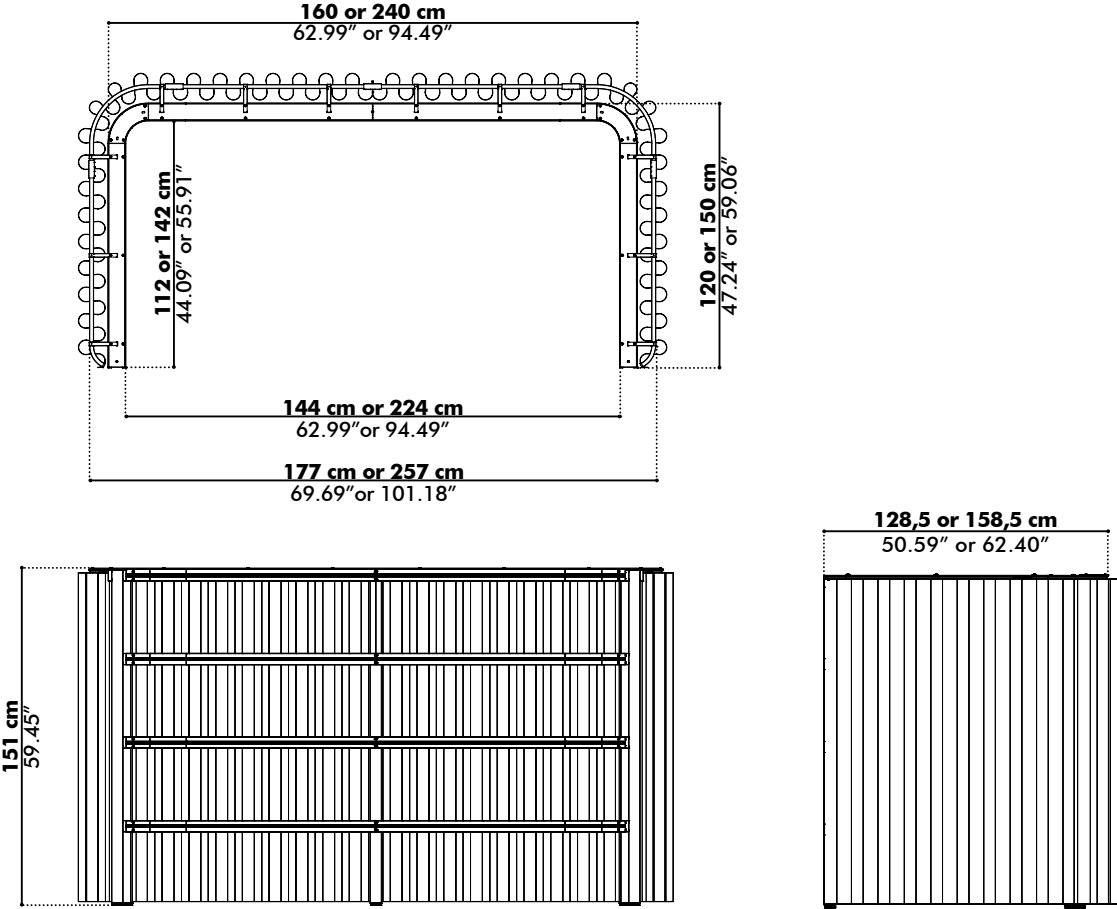

* Dimensions excl. rails & curtains

Bracks High

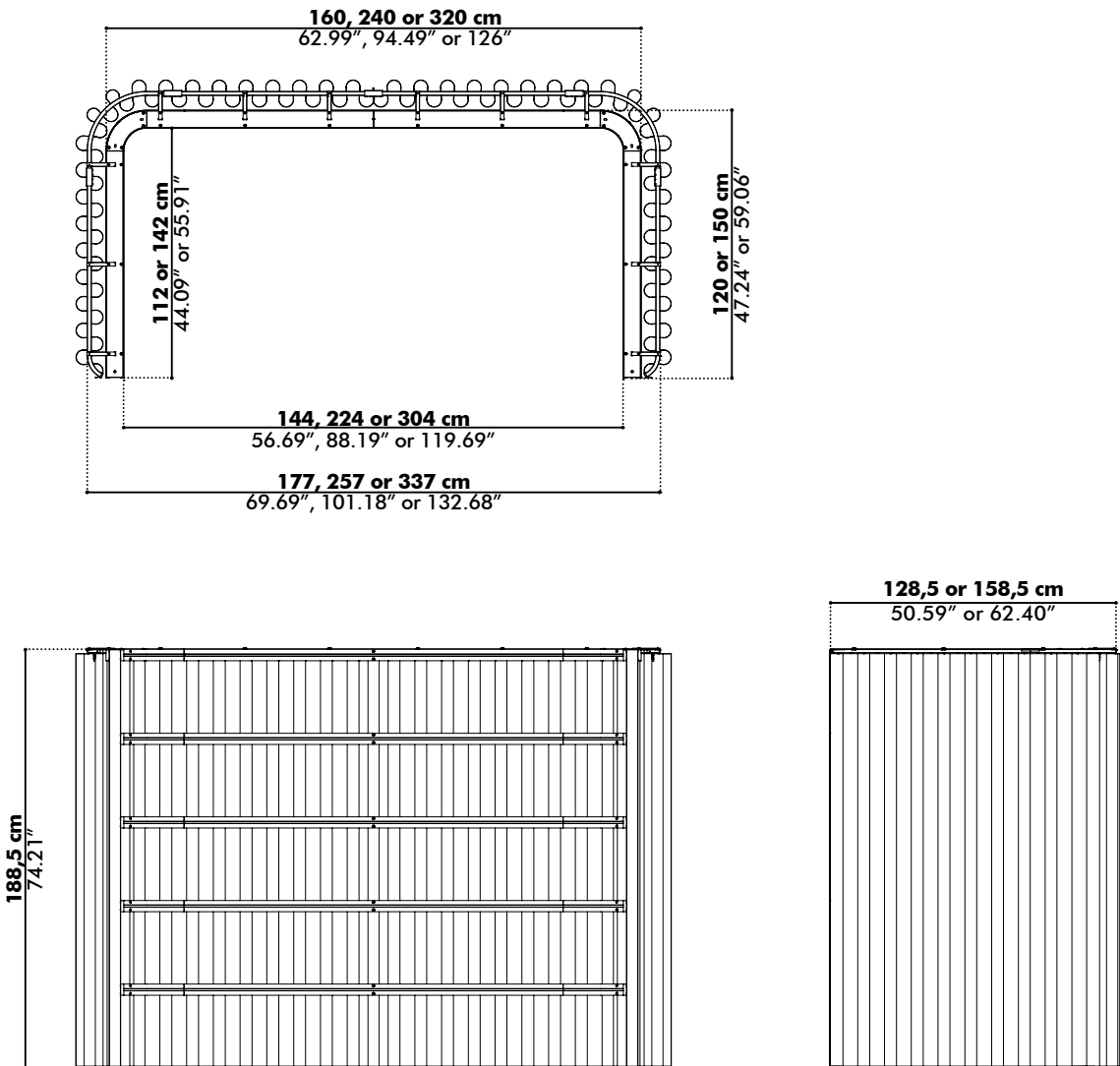

* Dimensions excl. rails & curtains

Extra High

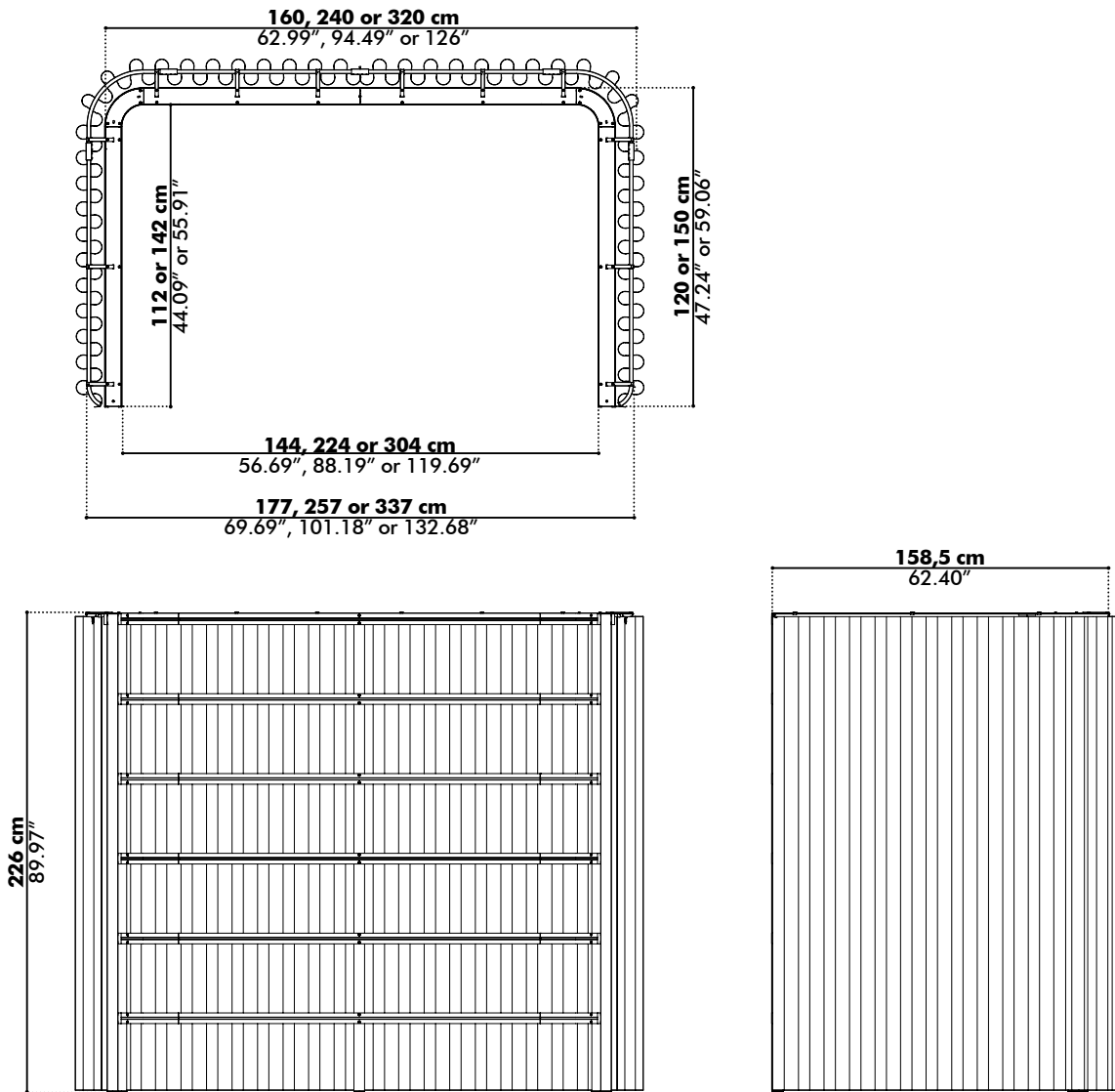

* Dimensions excl. rails & curtains

Shelves

Shelf Full for Bracks width 160 or 240

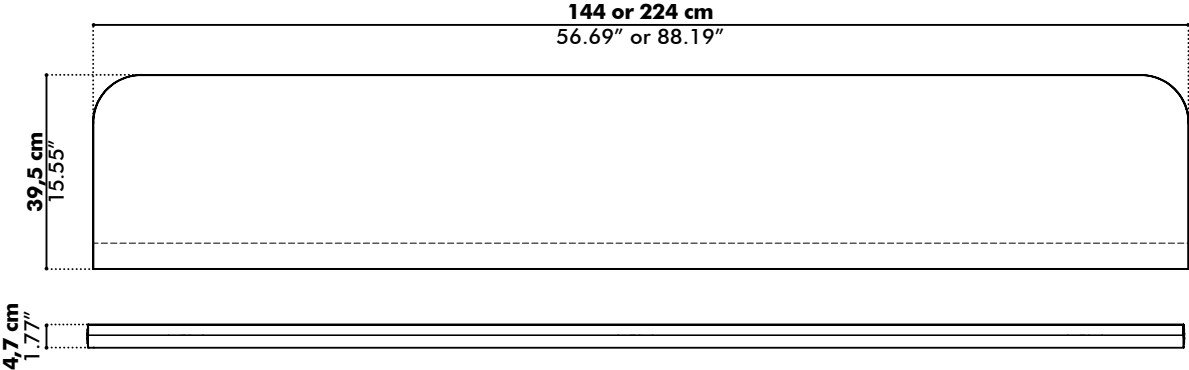

Shelf A

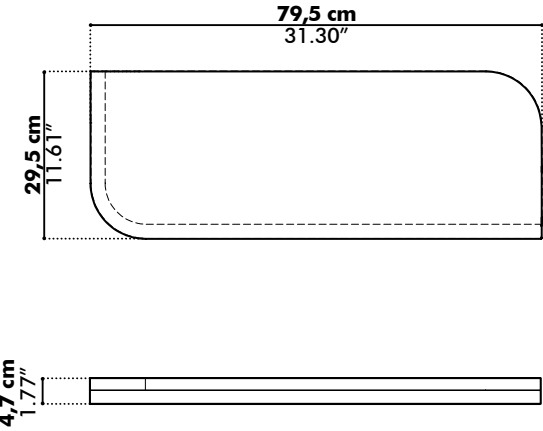

Shelf B

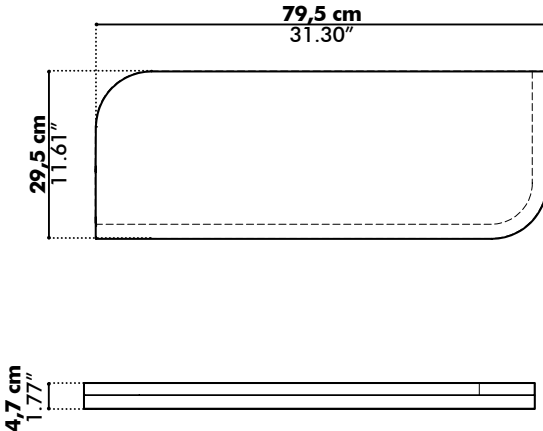

Worktops

Worktop Full for Bracks width 160 or 240

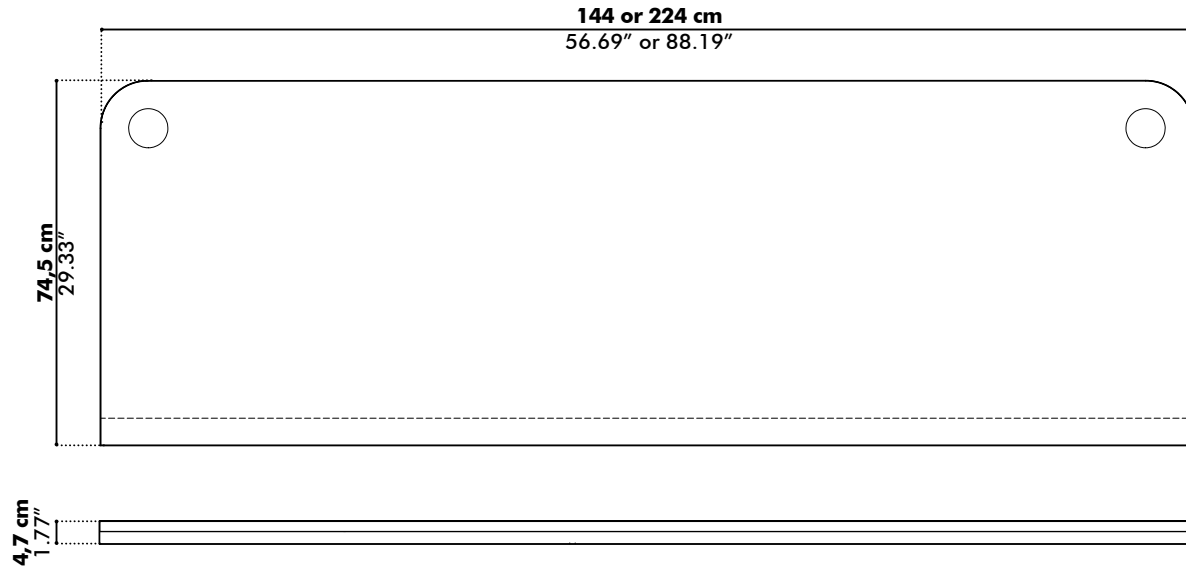

Cutouts for electrification are optional: **80 mm** - 3.15"

Worktop A for Bracks depth 120 or 150

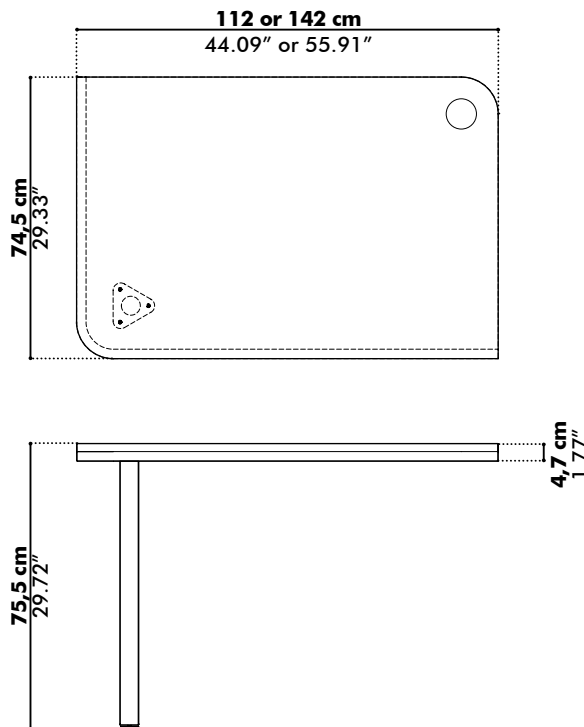

Worktop B for Bracks depth 120 or 150

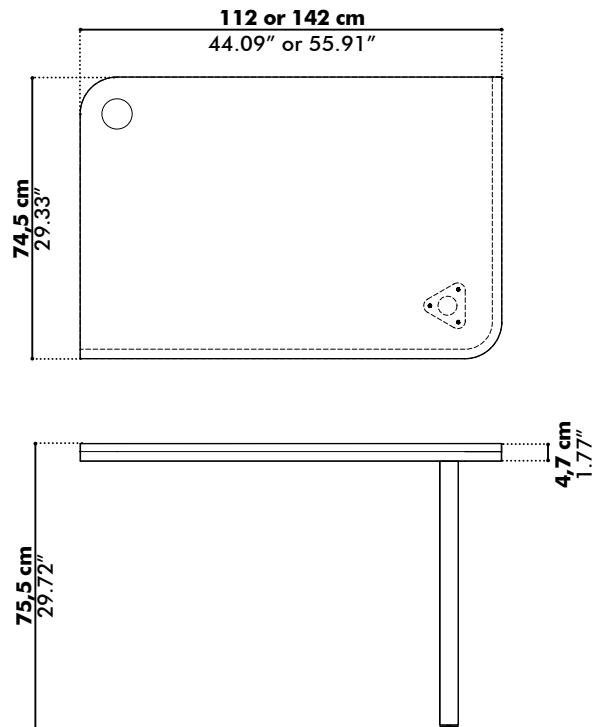

Cutouts for electrification are optional: **80 mm** - 3.15"

Meat

Medium

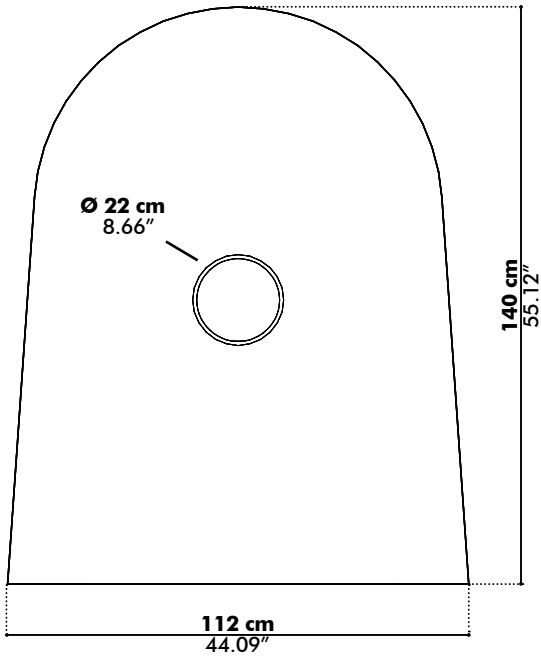

Large

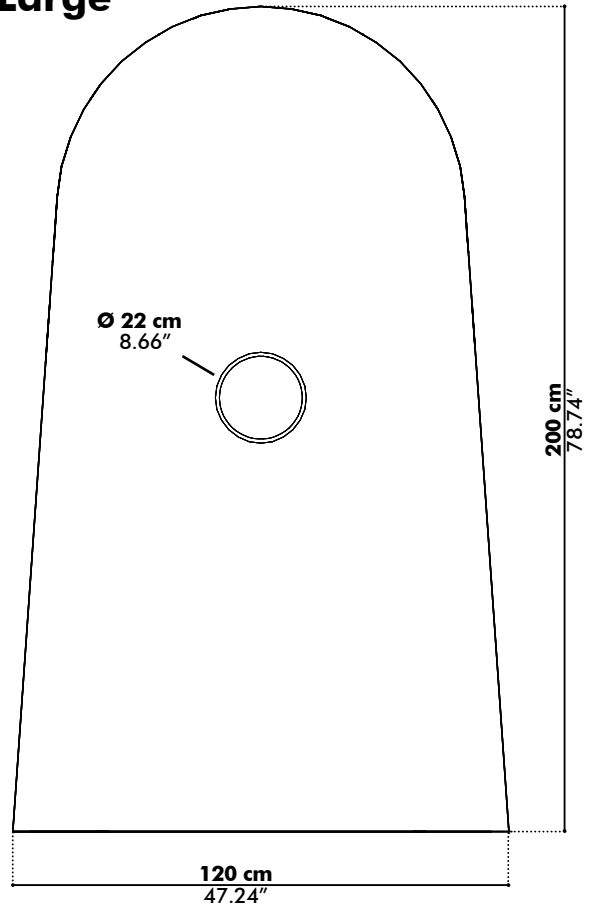

Low

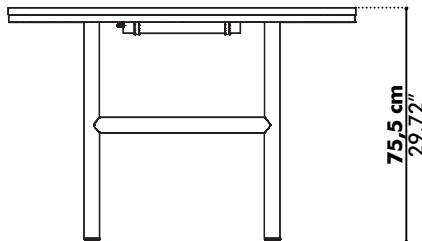

High

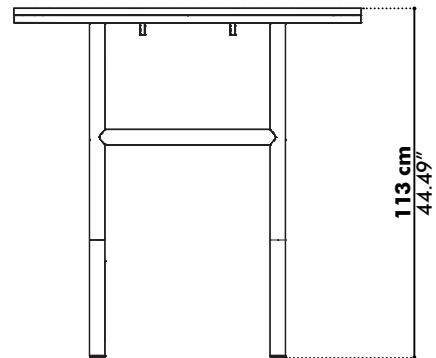

Cover

Width 160

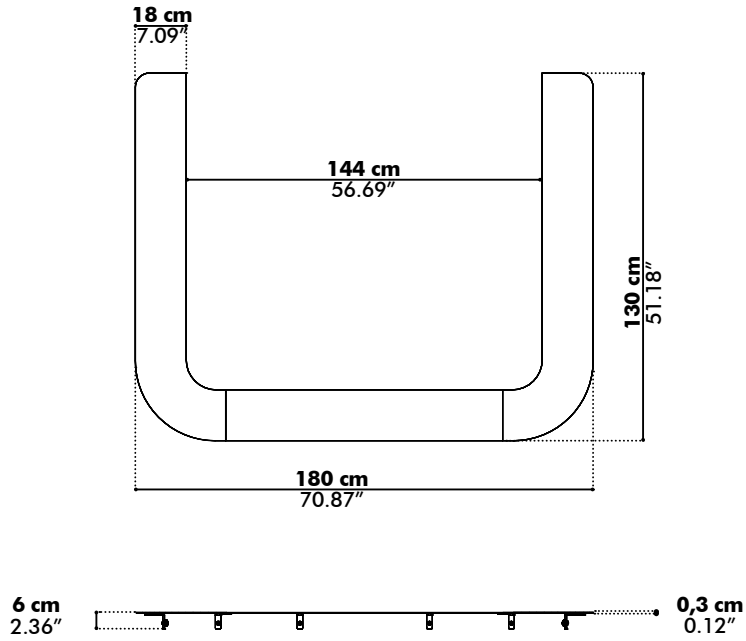

Width 240 or 320

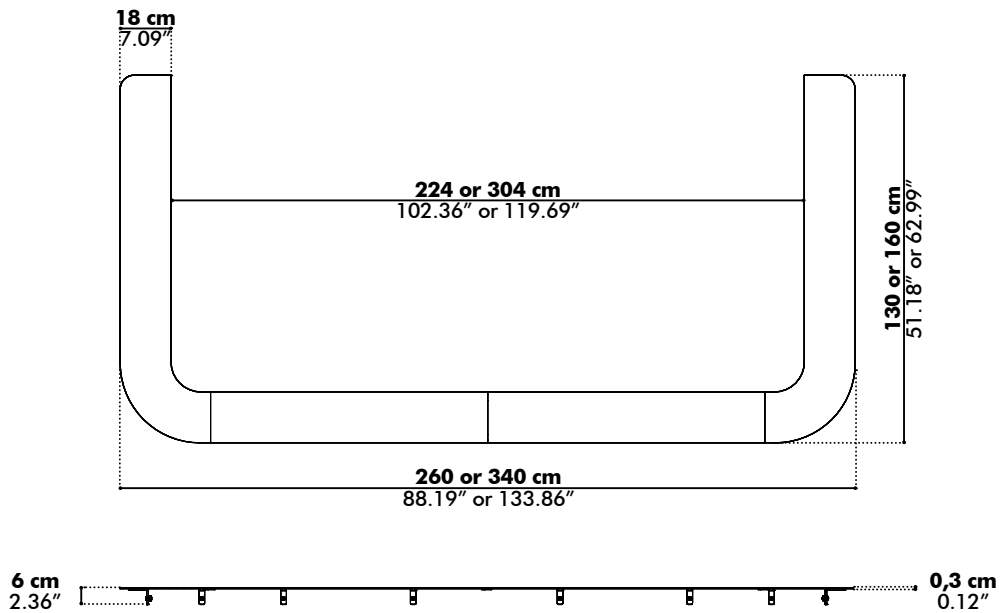

Acoustics

BuzziBracks Drops Acoustic Height 188.5 cm | 74.21

Equivalent sound absorption area in m² per object

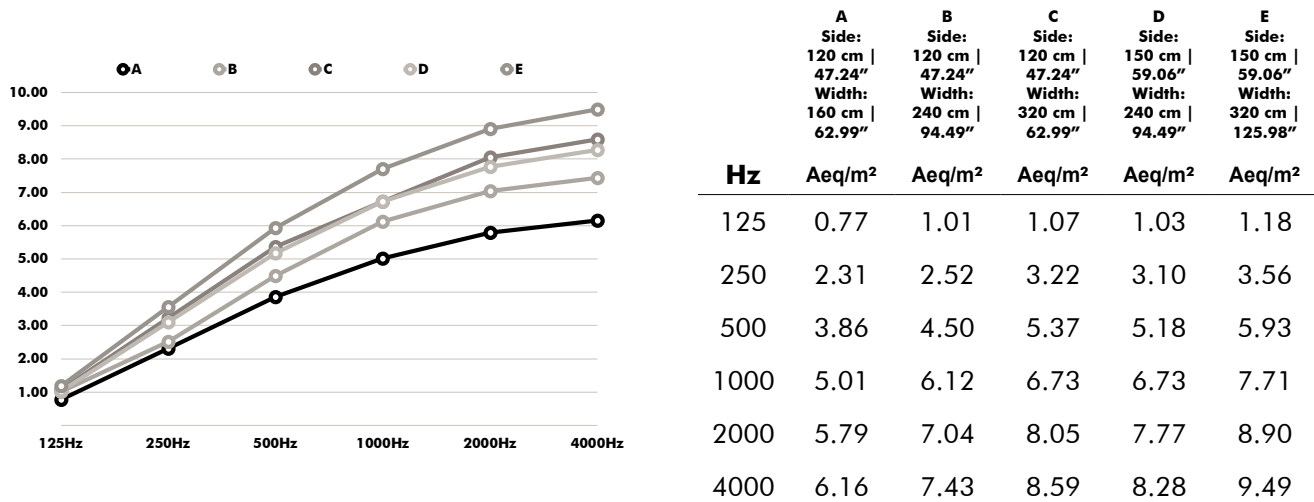

BuzziBracks Drops Acoustic Height 226 cm | 88.98"

Equivalent sound absorption area in m² per object

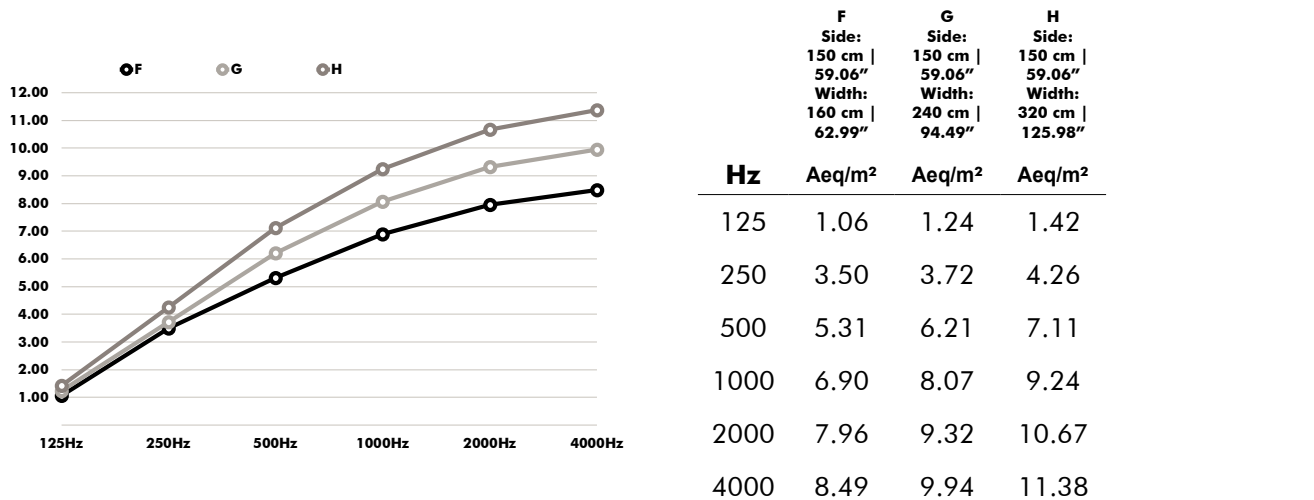

BuzziBracks Velvet Height 188.5 cm | 74.21

Equivalent sound absorption area in m² per object

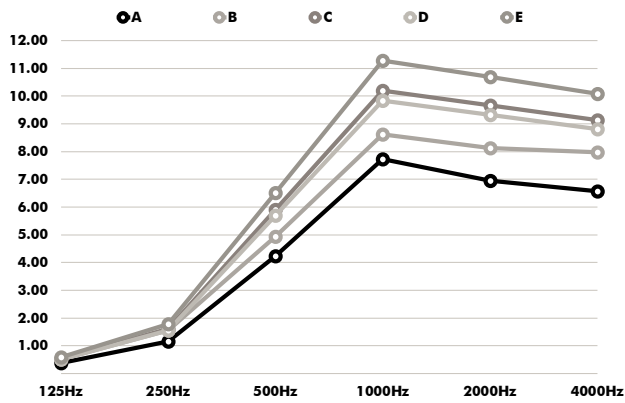

	A	B	C	D	E
	Side: 120 cm 47.24" Width: 160 cm 62.99"	Side: 120 cm 47.24" Width: 240 cm 94.49"	Side: 120 cm 47.24" Width: 320 cm 62.99"	Side: 150 cm 59.06" Width: 240 cm 94.49"	Side: 150 cm 59.06" Width: 320 cm 125.98"
Hz	Aeq/m ²	Aeq/m ²	Aeq/m ²	Aeq/m ²	Aeq/m ²
125	0.38	0.51	0.53	0.51	0.59
250	1.15	1.55	1.61	1.55	1.78
500	4.24	4.94	5.90	5.69	6.52
1000	7.73	8.61	10.2	9.84	11.27
2000	6.94	8.12	9.66	9.32	10.68
4000	6.56	7.97	9.13	8.80	10.08

BuzziBracks Velvet Height 226 cm | 88.98"

Equivalent sound absorption area in m² per object

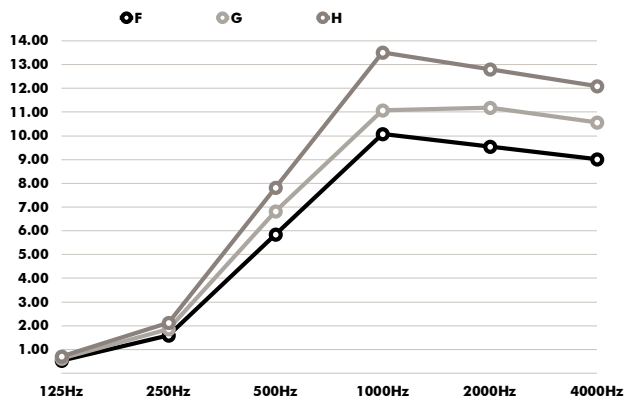

	F	G	H
	Side: 150 cm 59.06" Width: 160 cm 62.99"	Side: 150 cm 59.06" Width: 240 cm 94.49"	Side: 150 cm 59.06" Width: 320 cm 125.98"
Hz	Aeq/m ²	Aeq/m ²	Aeq/m ²
125	0.53	0.62	0.71
250	1.59	1.86	2.13
500	5.84	6.83	7.82
1000	10.08	11.80	13.51
2000	9.55	11.18	12.80
4000	9.02	10.56	12.09